

# ANNUAL REPORT 2021

Financial Intelligence Unit of Sri Lanka



# CONTENTS

Page

<b>LIST OF ACRONYMS .....</b>	<b>5</b>
<b>YEAR 2021 AT A GLANCE .....</b>	<b>7</b>
<b>National Coordinating Committee Chairman's Message.....</b>	<b>8</b>
<b>Director's Message.....</b>	<b>10</b>
<b>Functional Organizational Chart.....</b>	<b>13</b>
<b>Vision, Mission and Strategic Goals.....</b>	<b>14</b>
<b>CHAPTER 1: MANAGEMENT OF INTELLIGENCE .....</b>	<b>15</b>
1.1 Collection of Data/Information .....	15
1.2 Facilitating Law Enforcement Agencies (LEAs) .....	23
<b>CHAPTER 2: DOMESTIC AND INTERNATIONAL COOPERATION.....</b>	<b>26</b>
2.1 Domestic Cooperation.....	26
2.1.1 Competent Authorities .....	26
2.1.2 Regulatory Authorities.....	26
2.1.3 Memorandum of Understanding (MOUs) with Domestic Agencies....	27
2.1.4 Other Forms of Domestic Cooperation .....	27
2.2 International Cooperation .....	28
2.2.1 Exchange of Information with Counterpart Financial Intelligence Units (FIUs) .....	28
2.2.2 Memoranda of Understanding (MOUs) with Counterpart FIUs.....	29
2.2.3 The Asia Pacific Group on Money Laundering (APG) .....	29
2.2.4 Egmont Group .....	30
2.2.5 Financial Action Task Force (FATF) .....	31

2.3	Technical Assistance (TA) through International Cooperation.....	31
2.3.1	US Department of Treasury.....	31
2.3.2	The Asia Pacific Group on Money Laundering (APG) Regional Webinar Series – Designated Non-Financial Businesses and Professions (DNFBPs) Regulation: Financial Action Task Force (FATF) International Standards and Implementation.....	31
2.3.3	Other Technical Assistance (TA) Projects.....	32

### **CHAPTER 3: INSTITUTIONAL COMPLIANCE.....33**

3.1	Supervision of Financial Institutions.....	33
3.1.1	Legal Background of AML/CFT Supervision of Financial Institutions (FIs).....	33
3.1.2	ML/TF Risk Assessment.....	33
3.1.3	AML/CFT Examinations.....	35
3.1.4	Supervisory Actions Taken in 2021.....	38
3.1.5	Meetings Conducted with Financial Institutions (FIs) in 2021.....	41
3.1.6	Thematic Reviews Conducted in 2021.....	41
3.1.7	Measures Taken to Strengthen Institutional Compliance and Create Public Awareness in 2021.....	42
3.1.8	Way Forward.....	42
3.2	Supervision of Designated Non-Finance Businesses and Professions (DNFBPs).....	43
3.2.1	Introduction.....	43
3.2.2	Risk-Based Supervision of DNFBPs.....	43
3.2.3	Strengthening the AML/CFT Regime for Designated Non-Financial Businesses and Professions (DNFBPs).....	46
3.2.4	Way Forward.....	49

### **CHAPTER 4: CAPACITY BUILDING.....50**

4.1	Training Opportunities During 2021.....	52
-----	---	----

4.2 Trending Developments in Capacity Building .....	52
--	----

## **CHAPTER 5: AWARENESS PROGRAMMES.....53**

5.1 Seminars and Workshops Organised by FIU-Sri Lanka.....	53
5.2 Depth and Breadth of Awareness Programmes Conducted during 2016-2021 .....	58
5.3 Awareness through Print and Electronic Media .....	58

## **CHAPTER 6: IT INFRASTRUCTURE FOR REPORTING..... 60**

6.1 Introduction.....	60
6.2 LankaFIN Online Reporting System.....	60
6.2.1 Submission of STRs through LankaFIN .....	63
6.2.2 Analysis Using LankaFIN .....	63
6.3 The goAML Software System.....	63
6.3.1 Introduction.....	67
6.3.2 Implementing the goAML System .....	68
6.4 The FIU-Sri Lanka Website.....	69
6.5 Assistance Provided for Law Enforcement Agencies (LEAs) on Information Management and Sharing .....	70
6.6 Future Challenges .....	70

## **CONTACT US .....67**

## **Photo Gallery .....68**

## **Appendix A : List of Rules/Directions/Guidelines Issued From 2006 to 2021 .....74**

## **Appendix B: Reporting Institutions (RIs) as at 31 December 2021 .....79**

# LIST OF ACRONYMS

ADB	-	Asian Development Bank
AGD	-	Attorney General's Department
AML	-	Anti-Money Laundering
APG	-	Asia Pacific Group on Money Laundering
BOD	-	Board of Directors
BSD	-	Bank Supervision Department
CBSL	-	Central Bank of Sri Lanka
CDD	-	Customer Due Diligence
CEO	-	Chief Executive Officer
CFT	-	Countering the Financing of Terrorism
CID	-	Criminal Investigation Department
CIABOC	-	Commission to Investigate Allegations of Bribery or Corruption
CIDA	-	Construction Industry Development Authority
CMA	-	Condominium Management Authority
CNI	-	Chief of National Intelligence
CO	-	Compliance Officer
CSTFA	-	Convention on the Suppression of Terrorist Financing Act No. 25 of 2005
CTID	-	Counter Terrorism and Investigation Division
CTRs	-	Cash Transactions Reports
DFE	-	Department of Foreign Exchange
DMI	-	Directorate of Military Intelligence
DMS	-	Data Management Systems
DNFBPs	-	Designated Non-Finance Businesses and Professions
DRP	-	Department for Registration of Persons
DSNBFI	-	Department of Supervision of Non-Bank Financial Institutions
DSPM	-	Daily STR Prioritization Meeting
EDD	-	Enhanced Due Diligence
EFTs	-	Electronic Fund Transfers
FATF	-	Financial Action Task Force
FIs	-	Financial Institutions
FIU	-	Financial Intelligence Unit
FIU-Sri Lanka	-	Financial Intelligence Unit of Sri Lanka
FSRBs	-	Financial Action Task Force-Style Regional Bodies
FTRA	-	Financial Transactions Reporting Act No. 6 of 2006
FURs	-	Follow-up Reports
HOCID	-	Organized Crimes Investigations Division
ICs	-	Insurance Companies
ICASL	-	Institute of Chartered Accountants of Sri Lanka
IMF	-	International Monetary Fund
IPAID	-	Illegal Property or Assets Investigation Division
IRCSL	-	Insurance Regulatory Commission of Sri Lanka

KYC	-	Know Your Customer
LBs	-	Licensed Banks
LC	-	Largely Compliant
LCBs	-	Licensed Commercial Banks
LEAs	-	Law Enforcement Agencies
LFCs	-	Licensed Finance Companies
LSBs	-	Licensed Specialized Banks
ME	-	Mutual Evaluation
MEC	-	Mutual Evaluation Committee
MER	-	Mutual Evaluation Report
ML	-	Money Laundering
MOD	-	Ministry of Defence
MOU	-	Memorandum of Understanding
MVTS	-	Money or Value Transfer Services
NCC	-	National Coordinating Committee
NGJA	-	National Gem and Jewellery Authority
NGOs	-	Non-Governmental Organizations
NPOs	-	Not-for-Profit Organizations
NRA	-	National Risk Assessment
OTA	-	Office of Technical Assistance
PC	-	Partially Compliant
PEPs	-	Politically Exposed Persons
PMLA	-	Prevention of Money Laundering Act No. 5 of 2006
PNB	-	Police Narcotic Bureau
RAs	-	Regulatory Authorities
RBA	-	Risk-Based Approach
RDs	-	Restricted Dealers (formerly Authorized Money Changers)
RED	-	Resolution and Enforcement Department
RI	-	Reporting Institutions
ROC	-	Registrar of Companies
SBs	-	Stock Brokers
SEC	-	Securities and Exchange Commission of Sri Lanka
SIS	-	State Intelligence Service
STF	-	Special Task Force
STRs	-	Suspicious Transaction Reports
TCSPs	-	Trusts and Company Service Providers
TF	-	Terrorist Financing
TFS	-	Targeted Financial Sanctions
UNODC	-	United Nations Office on Drugs and Crime
UNSCRs	-	United Nations Security Council Resolutions
USA	-	United States of America
USD	-	United States Dollars
VAs	-	Virtual Assets
VASPs	-	Virtual Asset Service Providers

# YEAR 2021 AT A GLANCE...



Sri Lanka Initiated the Second National Risk Assessment for Sri Lanka



5.7 Mn CTRs  
9.2 Mn EFTs



4,696 STRs  
30% increase in STRs



FIU Imposed penalties on 9 Financial Institutions totaling to Rs. 10.5 Mn

65 Awareness Programmes



Over 5,000 Participants



Issued

3 Guidelines  
4 Circulars  
6 Press Notices



FIU shared information with foreign counterpart FIUs

Sri Lanka made 49 requests and responded to 19 requests from counterpart FIUs



9 on-site and spot examinations



7 Off-site thematic examinations



4 Follow up examinations



7 Joint Supervisions



5 Warning Letters



Update notifications sent on the UN Security Council Sanctions lists

pursuant to UNSCR 1373, 1267, 1988, 1989, 2253 and subsequent resolutions on Al-Qaeda, ISIL and Taliban Terrorists

# NATIONAL COORDINATING COMMITTEE CHAIRMAN'S MESSAGE



I am very pleased to present the Annual Report of the Financial Intelligence Unit of Sri Lanka (FIU-Sri Lanka) for the year 2021 in a context where the necessity has arisen to further strengthen our legal framework to eliminate financial crimes. The FIU-Sri Lanka is empowered with greater responsibility as the focal point of strengthening the regime of anti-money laundering and countering the financing of terrorism (AML/CFT) to facilitate such necessity while strengthening the AML/CFT regime of the country following the international standards and best practices.

In this context, I believe that the results of the national risk assessment which is to be finalised in 2022 will provide strategic direction for the country in order to further strengthen AML/CFT regime and make Sri Lanka a financial crime-free country. The long prevailed COVID-19 pandemic provided opportunities to the criminals to change the traditional way of money laundering. The increased use of technology and the interest of the younger generation in virtual assets are the areas where the stakeholders are required to concentrate on mitigating ML /TF risks. Therefore, a strong awareness programme is an essential component of strengthening the AML/CFT regime of the country.

Sri Lanka has achieved significant progress since it was delisted from the Grey List of the Financial Action Task Force (FATF) in 2019. Therefore, we are to focus on further strengthening inter-agency cooperation in both domestic and international contexts.

The FIU has taken various measures to improve the compliance level of reporting institutions with the implementation of a sound risk-based supervisory regime. The FIU closely engages with other sectoral regulators to improve institutional compliance. The pandemic situation compelled the FIU to adopt novel supervisory approaches which included offsite desk reviews and thematic examinations of identified high-risk areas, and such approaches were highly successful given the available resources.



The shift to an internationally endorsed goAML software system will enhance the quality of reporting of institutions and analytical skills of the analysts of FIU. Further, it will enhance the quality and efficiency of the communication among stakeholders.

The Global AML/CFT standards are regularly changing and evolving. In this context, the FIU and the stakeholders will take necessary measures to improve the compliance level of Sri Lanka and, thereby the stakeholders are to adopt efficient and effective measures to implement the AML/CFT regime of the country. This will be challenging for FIU-Sri Lanka as well as the other stakeholders. Therefore, Sri Lanka is to focus on developing a sound legal framework and implementing the same with the support of stakeholders.

I wish FIU-Sri Lanka every success in their future endeavours.

**Dr. P Nandalal Weerasinghe**

Governor of the Central Bank of Sri Lanka

Chairman of the AML/CFT National Coordinating Committee

# DIRECTOR'S MESSAGE

Amidst the challenges presented during 2021, FIU-Sri Lanka continued its operations to strengthen the Anti-Money Laundering/Countering the Financing of Terrorism (AML/CFT) regime of the country in terms of the statutory provisions of the Financial Transactions Reporting Act No. 6 of 2006 (FTRA) and in line with international standards.

Year 2021 presented a significant milestone for Sri Lanka and for the FIU as the FIU-Sri Lanka commenced its second National Risk Assessment in July 2021 with the technical assistance received from the World Bank. The Risk Assessment is looking into 13 areas represented as modules including the new areas of Legal Persons, Virtual Asset Service Providers, Environmental Crimes, and the Non-Governmental Organizations sectors. Albeit facing numerous external challenges including the COVID-19 pandemic related lockdowns, I am happy to see that we are on target to complete this assessment by last quarter of 2022.

FIU Sri Lanka continued its core functions to serve as the national agency that receives and analyses suspicious transaction reports and other information relevant to money laundering and financing of terrorism and disseminated the results from such analyses to Law Enforcement Agencies and/or Supervisory Authorities for further investigation. FIU-Sri Lanka worked well within the contingency parameters to overcome work related challenges presented during the COVID-19 pandemic and discharge its statutory responsibilities and short and medium-term objectives with the assistance of stakeholders.

I am glad to say that the FIU staff members attended to and discharged their duties and responsibilities with minimum disruption to operations. The FIU continued to receive Cash Transaction Reports (CTRs) and Electronic Fund Transfers (EFTs) exceeding the threshold of Rs. 1.0 million or its equivalent in foreign currencies and Suspicious Transaction Reports (STRs) from Reporting Institutions (RIs) as mandated by the FTRA.

The total number of CTRs and EFTs showed an upward trend during the year. FIU-Sri Lanka

received around 4,700 STRs, which is a significant increase of 30% compared to the previous year. CTRs and EFTs were also high during the year, recording 22% and 25% increase respectively, from those received in 2020.

Year 2021 saw the issuance of several guidance notes and circulars to the Financial Institutions to assist their AML/CFT related activities during the pandemic period. These include the Guidelines on Implementation of AML/CFT measures on parties involved with online payment platforms, Trends in Foreign Currency Outflows via ATMs: Cash withdrawals in overseas, Measures to mitigate the emerging Money Laundering/ Terrorist Financing risks during the third wave of the COVID-19 Pandemic, and Guidelines for Financial Institutions on CCTV Operations for AML/CFT Purposes. FIU-Sri Lanka also issued guidelines to streamline the suspension activities it carries out to assist the law enforcement authorities via Guidelines for Financial Institutions on Suspension of Transactions under the FTRA.

With the aim to ensure institutional compliance the FIU- Sri Lanka carried out several risk-based on-site examinations, follow-up examinations and on-site spot examinations on FIs, including joint examinations with sector specific regulators. Further, risk-based on-site examinations and follow-up examinations were also conducted on high-risk Designated Non-Financial Businesses and Professions (DNFBPs). Several off-site risk assessments and thematic studies were carried out to expand the understanding of ML/TF risk for identified DNFBP sectors.

During the year, although lock down measures prevented close contact events, the FIU carried out 65 awareness and outreach events on AML/CFT, participated by over 5000 participants. Ensuring cooperation within and across the region FIU-Sri Lanka shared information on 19 occasions with foreign counterparts. The FIU-Sri Lanka reached out to members of the Egmont Group on 45 occasions for assistance to carry out investigations and collaborated with member countries to gather intelligence on their investigations.

Marking another success, the FIU-Sri Lanka and the licensed banks were able to commence live operations of goAML phase 'Call for Information (CFI)' from August 2021. Despite the restricted working conditions during the COVID-19 pandemic, substantial progress has been reached in the process of shifting to the goAML system, with live reporting scheduled to February 2022.

Despite the challenges, the FIU-Sri Lanka functioned well to mitigate ML/TF threats posed by unprecedented events to the financial and designated non-financial businesses. In the coming year, we would see the successful completion of the National Risk Assessment of Sri Lanka, which will pave the way for National AML/CFT policy for the next five-year period.

We would commence the remaining Phases for goAML system to proceed to live operations which in turn, would further strengthen the AML/CFT reporting and analysis process of the FIU. We would strive to strengthen the AML/CFT regime of the country through increased engagement with the compliance community for the reporting institutions. As the Focal point for AML/CFT framework in the country we look forward to harness opportunities to work more closely with our stakeholders and expand on our relationships with several international counterparts and agencies through MOUs to support the global initiatives of AML/CFT.

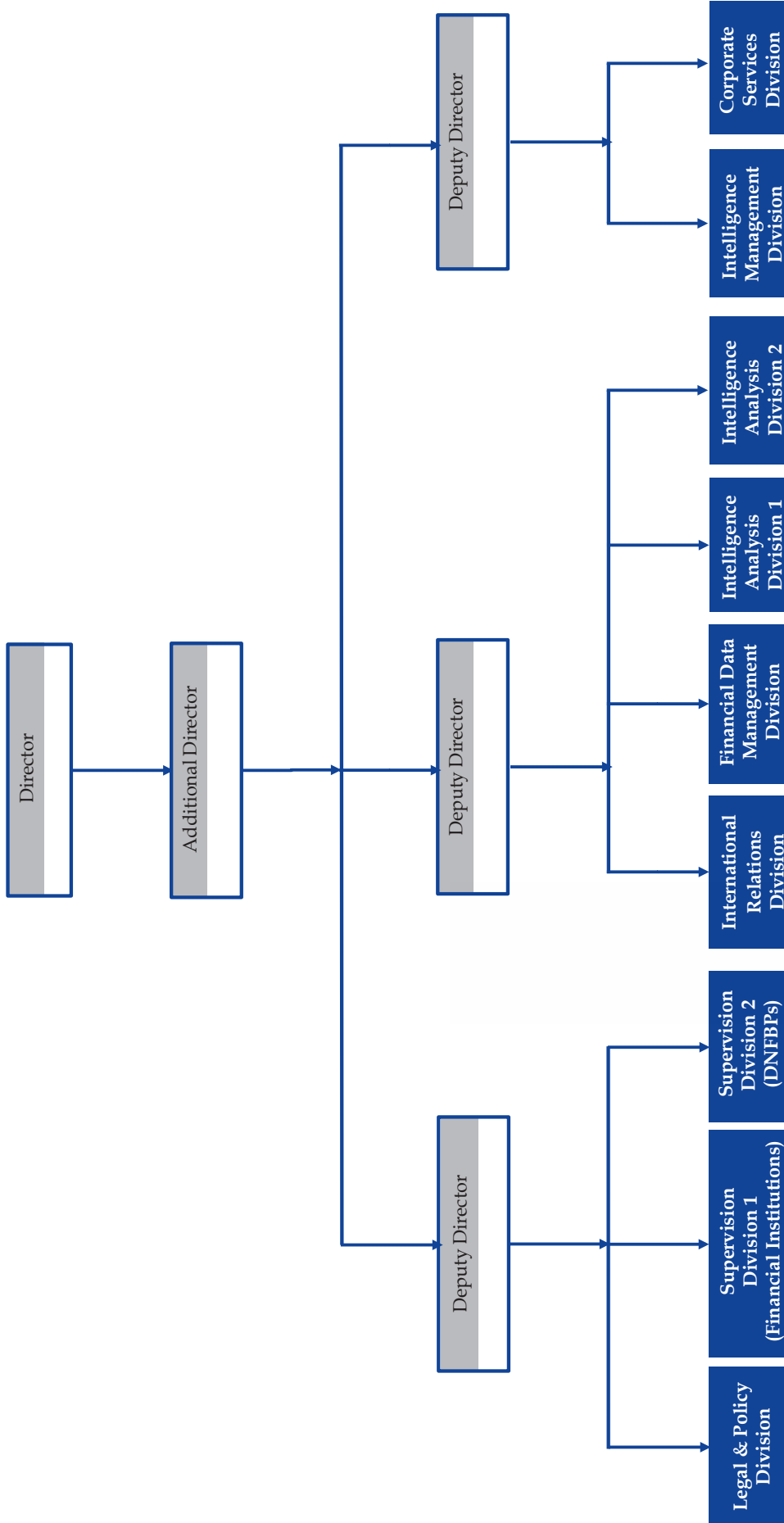
I look forward to delivering on our objectives and maintaining the high standards instilled within this agency towards the betterment of the AML/CFT framework for Sri Lanka.

**E H Mohotty**

Director

Financial Intelligence Unit of Sri Lanka

# FUNCTIONAL ORGANIZATIONAL CHART OF THE FIU-SRI LANKA



## VISION, MISSION, AND STRATEGIC GOALS

### VISION

To be the trusted and respected single agency with a commitment to excellence in establishing the framework for Anti-Money Laundering and Countering the Financing of Terrorism (AML/CFT) in Sri Lanka.

To administer, effectively, the provisions of the Financial Transactions Reporting Act, No.6 of 2006 (FTRA) by facilitating the prevention, detection, investigation and prosecution of the offences related to Money Laundering and Terrorist Financing (ML/TF).

### MISSION

### STRATEGIC GOALS

Strengthening the AML/CFT measures in Sri Lanka in line with international practices.

Strengthening the co-operation with relevant international and domestic institutions to combat ML/TF.

As per the recommendations made by the Financial Action Task Force (FATF) which is the global policy setter against Money Laundering and Terrorist Financing (ML/TF), the Financial Intelligence Unit of Sri Lanka (FIU-Sri Lanka) was established in 2006 under the Financial Transactions Reporting Act No. 06 of 2006 (FTRA). The FIU-Sri Lanka is responsible for facilitating prevention, detection, investigation, and prosecution of offences relating to ML/TF and acts as the central national agency for collection, analysis, and dissemination of data and information related to Suspicious Transaction Reports (STRs) on ML/TF, reported by Reporting Institutions (RIs), Law Enforcement Agencies (LEAs), Regulatory Authorities (RAs), and the general public.

### 1.1 Collection of Data/Information

As empowered by Section 15(1) of the FTRA, the FIU-Sri Lanka mainly collects financial data through RIs as defined in the said Act. In terms of Section 7 of the FTRA, RIs are required to submit STRs to the FIU-Sri Lanka.

These STRs are primarily submitted through the GoAML system, a secure online reporting mechanism used by Licensed Banks (LBs), Licensed Finance Companies (LFCs), Stockbrokers (SBs), Insurance Companies (ICs) and Money or Value Transfer Services (MVTs) providers. Other RIs including Designated Non-Financial Businesses and Professions (DNFBPs) and the general public submit STRs in written/electronic form.

**Table 1.1**  
**STRs and Information Requests Reported by Stakeholders**

Category	2017	2018	2019	2020	2021
RIs	766	775	1,434	1,963	3,713
LEAs, Intelligence Agencies & RAs	157	227	1,281	1,561	871
Public Complaints	2	20	89	93	112
<b>Total</b>	<b>925</b>	<b>1,022</b>	<b>2,804</b>	<b>3,617</b>	<b>4,696</b>

*Source: LankaFIN, Financial Intelligence Unit-Sri Lanka*

As shown in Table 1.1 above, total of STRs and STRs reported through Information Requests made by LEAs to the FIU-Sri Lanka has shown an increasing trend since 2017 to date. A 30% increase can be seen in the total number of STRs, and Information Requests reported from 2020 (3,617) to 2021 (4,696). This increase is the net result of the increase in the STRs reported by RIs by 89%, public by 20%, and a decrease in the Information Requests submitted by LEAs, Intelligence Agencies and RAs, by 44%.

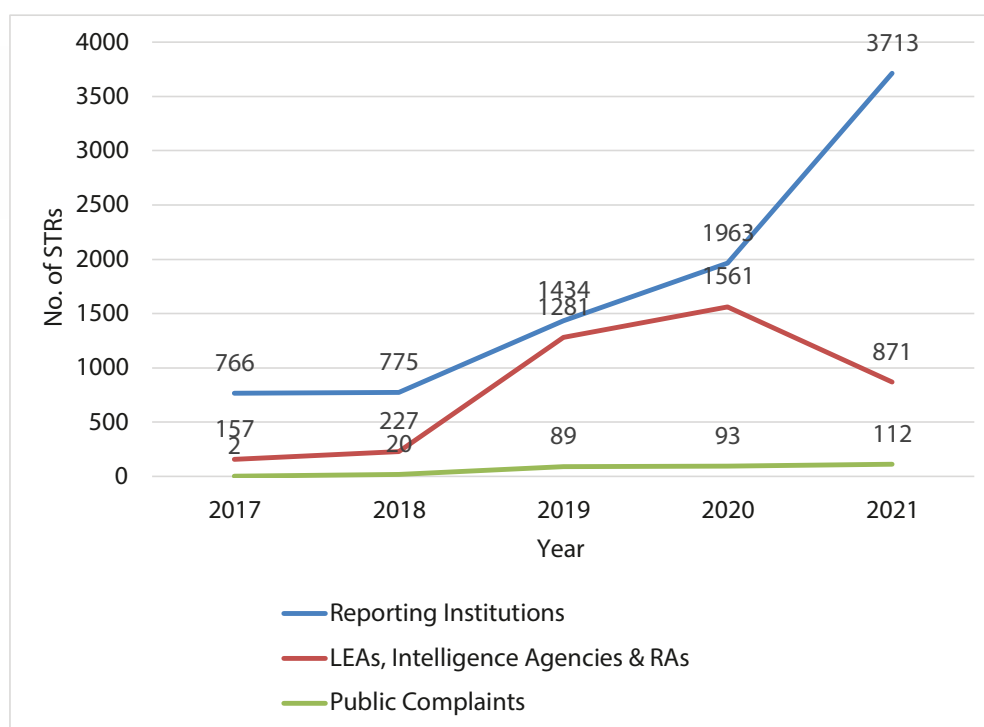
The 89% and 20% acceleration in the number of STRs reported by RIs and the public, respectively, during 2021 is due to several reasons as listed below.

- Trend identified pertaining to overseas ATM withdrawals during mid-March
- Increase in awareness campaigns conducted about financial scams
- Expansion and identification of informal money transfer channels such as Hawala/ Undiyal at the end of 2021

Refer Figure 1.1 below for a breakdown of STRs received from RIs, LEAs, Intelligence Agencies and RAs, and the general public from 2017 to 2021.

**Figure 1.1**

**STRs and Information Requests Reported by Stakeholders**



Source: LankaFIN, Financial Intelligence Unit-Sri Lanka



### 1.1.1 Suspicious Transaction Reports (STRs)

In simple terms, an STR is a document that an RI or a member of the general public files with the FIU-Sri Lanka whenever there is suspicion of offences related to ML/TF. Suspicion may be raised regarding either a committed or an attempted transaction. In terms of Section 7 of the FTRA, an RI is required to submit an STR when it has,

reasonable grounds to suspect that any transaction or attempted transaction may be related to the commission of any unlawful activity (as defined in Section 33 of the FTRA) or any other criminal offence;

information that it suspects may be relevant to an act preparatory to an offence under the provisions of the Convention on the Suppression of Terrorist Financing Act No. 25 of 2005 (CSTFA);

information that it suspects may be relevant to an investigation or prosecution of a person or persons for an act constituting an unlawful activity;

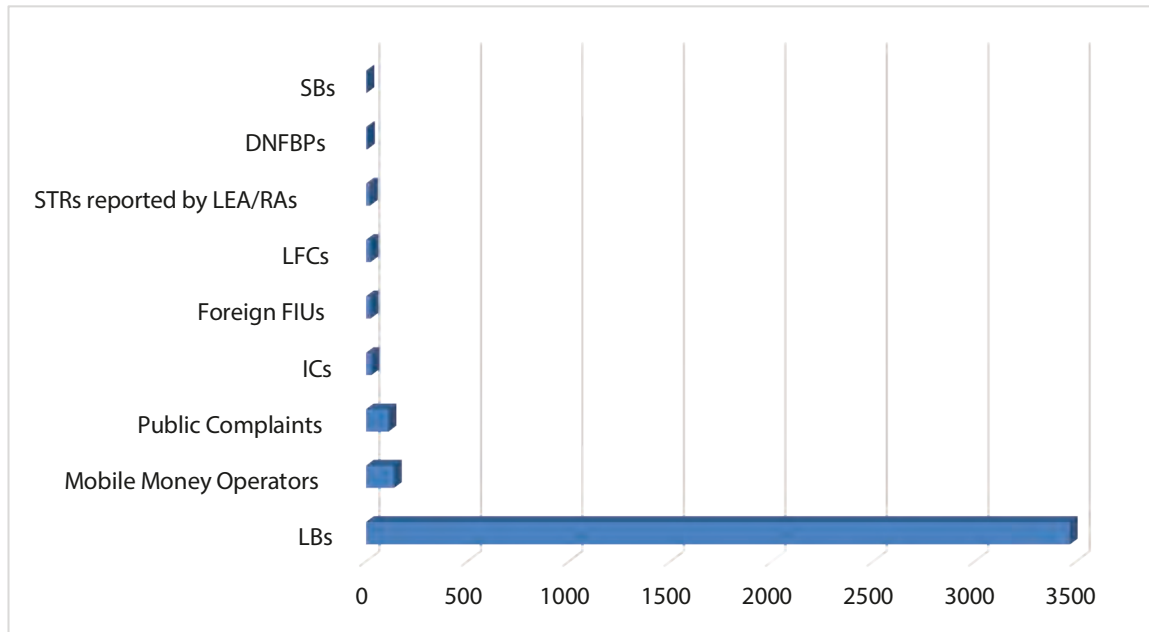
information that it suspects may be of assistance in the enforcement of the Prevention of Money Laundering Act No. 5 of 2006 (PMLA) and CSTFA.

RIs are required to report such suspicion to the FIU-Sri Lanka as soon as practicable, after forming that suspicion or receiving the information, but no later than two working days therefrom.

Further, in terms of Section 5 of the PMLA, any person who knows or has reason to believe from information or other matter obtained by him during any trade, profession, business or employment carried on by such person, that any property has been derived or realized from any unlawful activity, such person should disclose his knowledge or belief as soon as is practicable to the FIU-Sri Lanka.

### 1.1.1.1 Analysis of Trends and Patterns of STRs Received

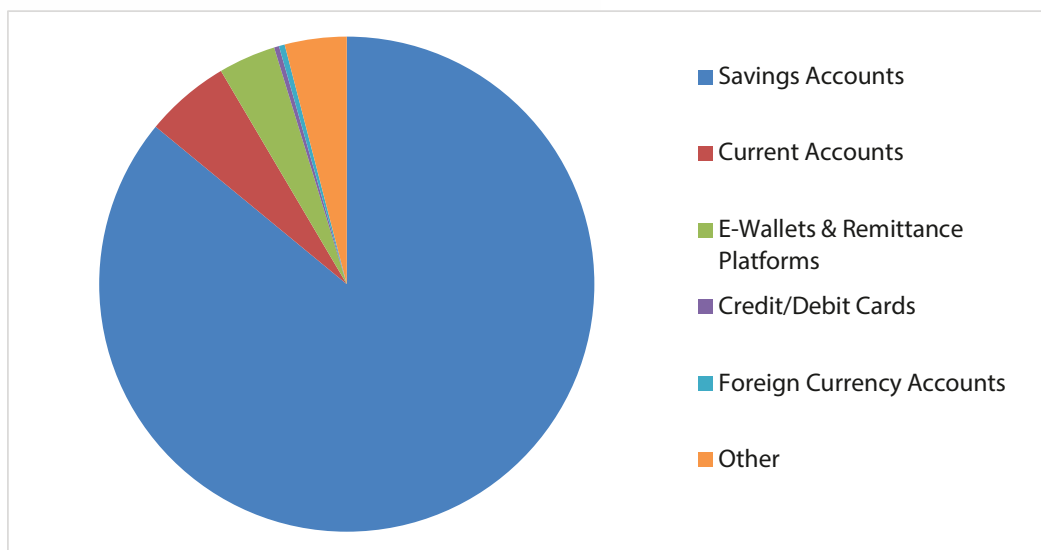
**Figure 1.2**  
**STRs by RI Type**



Source: LankaFIN, Financial Intelligence Unit-Sri Lanka

As shown in Figure 1.2, majority of the total STRs during 2021 were received from LBs which is 91%. Shares below 5% were reported by all other RIs.

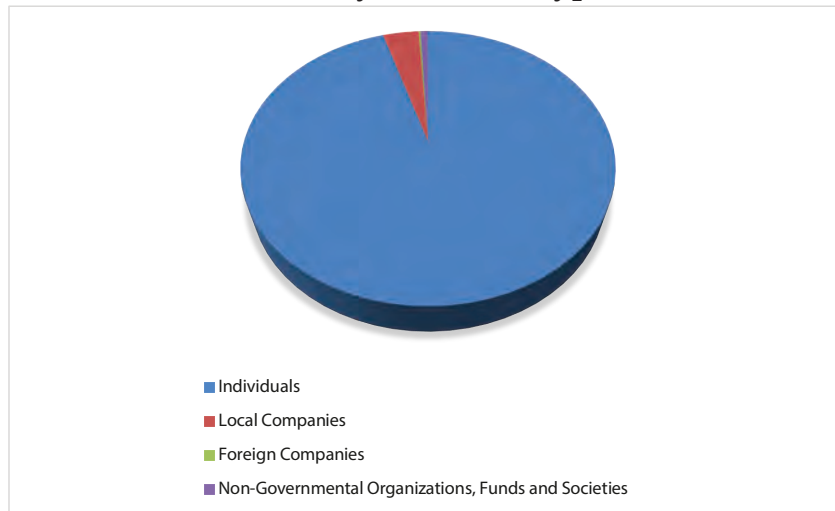
**Figure 1.3**  
**STRs by Product Type**



Source: LankaFIN, Financial Intelligence Unit-Sri Lanka

As shown in Figure 1.3 above, 86% of STRs received during 2021 were related to transactions performed through savings accounts. STRs related to transactions carried out through current accounts (6%), e-wallets & remittance platforms (4%), credit/debit cards and foreign currency accounts were very low. The other category (4%) includes STRs involving fixed deposits, safety deposit lockers, etc.

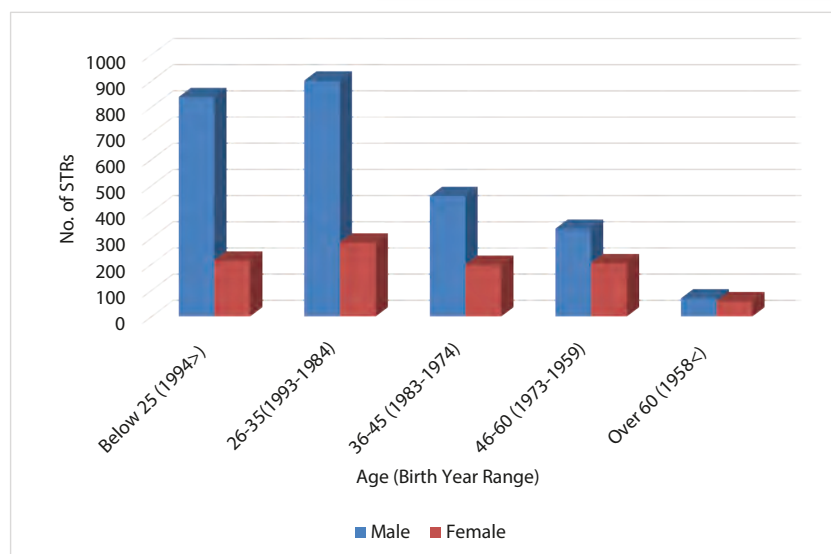
**Figure 1.4**  
**STRs by Customer Type**



Source: LankaFIN, Financial Intelligence Unit-Sri Lanka

Figure 1.4 shows that 95% of STRs received were related to suspicious financial transactions performed by individuals. However, a very low number of STRs received were related to Local Companies, Foreign Companies and Non-Governmental Organizations (NGOs) which totals to the remaining 5% of STRs.

**Figure 1.5**  
**Age and Gender-wise Analysis of STRs on Individuals**



Source: LankaFIN, Financial Intelligence Unit-Sri Lanka

As depicted in Figure 1.5, in terms of the gender-wise analysis of STRs received on individuals, the involvement of males in suspicious financial transactions was higher than that of females in all age categories. Out of the total STRs reported on males and females, the majority were in the age category of 26 to 35 years, and the second majority lies in the below 25 years age group. After analyzing the STRs received about digital assets, a trend was observed that a majority of the individuals related to the STRs were in the above age group.

### 1.1.1.2 Analysis of Information

Upon collecting financial data and information, they are analyzed by the Intelligence Management Division to identify trends and incidents related to ML/TF. Such an STR analysis process encompasses several steps:

- Initially, a preliminary analysis and assessment is performed for every STR received. Other available sources of information such as Cash Transactions Reports (CTRs), Electronic Fund Transfers (EFTs,) any other STRs reported to LankaFIN, 'InforID' system of the Department for Registration of Persons, 'ASYCUDA' system of Sri Lanka Customs, 'ACCUITY' database, etc. are also utilized to conduct the preliminary analysis. Such preliminary analysis enables the analysts to determine the depth of the STR and the nature of further actions to be taken.
- Subsequently, results of the preliminary analysis are presented at the Daily STR Prioritization Meeting (DSPM) chaired by the Additional Director/relevant Deputy Director of the FIU-Sri Lanka with the participation of relevant officials of the FIU-Sri Lanka. Where further analysis seems necessary, an operational analysis is performed by calling for further information from relevant local and foreign counterparties, if needed.
- Where further analysis seems necessary, an operational analysis is performed by calling for further information from relevant local and foreign counterparties, if needed.

As shown in Table 1.2 below, the number of STRs reported regarding ML continued to rise in 2021 because of various factors as explained in the beginning of this chapter.

**Table 1.2**  
**Composition of STRs**

	2017	2018	2019	2020	2021
<b>No. of STRs on TF</b>	58	116	969	591	<b>117</b>
<b>No. of STRs on ML</b>	867	906	1,835	3,026	<b>3,708</b>
<b>Total</b>	<b>925</b>	<b>1,022</b>	<b>2,804</b>	<b>3,617</b>	<b>3,825</b>

*Source: LankaFIN, Financial Intelligence Unit-Sri Lanka*  
*\*2021 information is presented only for STRs received from RIs and the general public.*

### 1.1.1.3 Dissemination of Information

Upon concluding the analysis process, the intelligence or the information generated through analysis is disseminated to relevant parties for the commencement of appropriate regulatory or further investigative actions. The STR dissemination process of the FIU-Sri Lanka consists of several steps:

- After conducting operational analysis, an analysis report is prepared for each relevant STR case and the same is submitted to the Daily STR Prioritization Meeting (DSPM) or the STR Review Committee headed by the Director of the FIU-Sri Lanka, along with senior official(s) representing the Attorney General's Department and relevant officials of the FIU-Sri Lanka.
- The analysis of STRs and related information are disseminated to relevant LEAs and/or RAs for further investigation or regulatory actions based on the decisions made at the DSPM or STR Review Committee.
- The said meeting/committee may decide not to disseminate certain STRs in the event where specific STRs do not warrant further investigation by LEAs or RAs.

A summary of STRs disseminated from 2017 to 2021 is given in Table 1.3 below:

**Table 1.3**  
**Dissemination of STRs**

	2017	2018	2019	2020	2021
<b>LEAs</b>	295	256	1,465	2,800	<b>1,081</b>
<b>RAs</b>	134	61	9	80	<b>92</b>

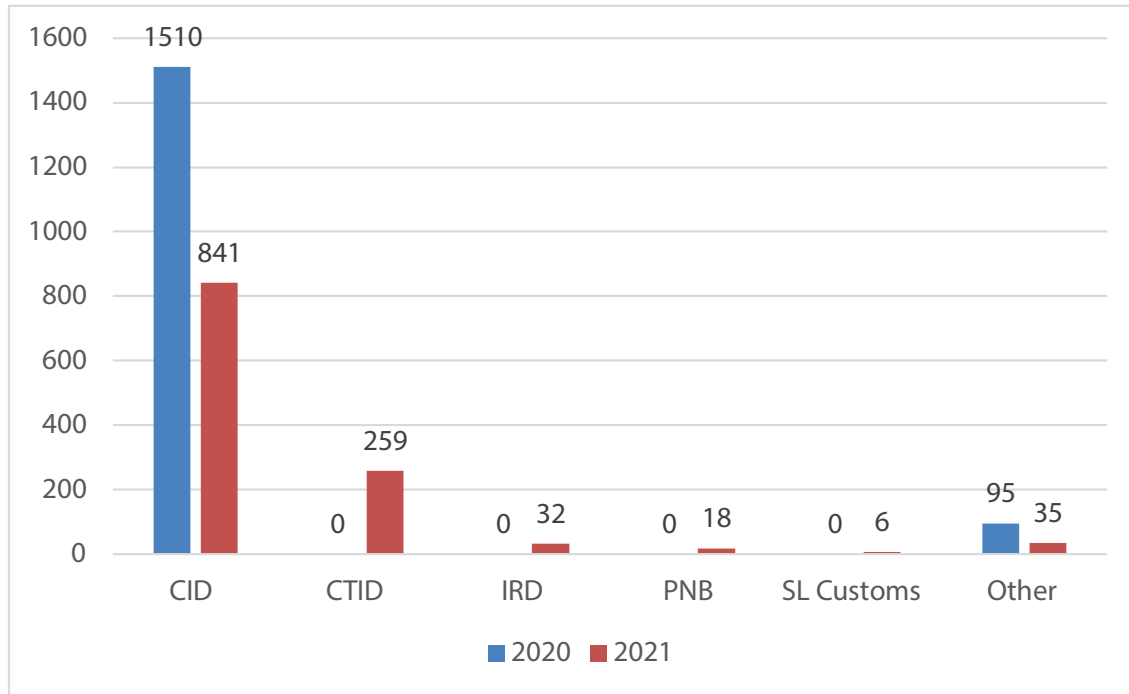
*Source: Financial Intelligence Unit-Sri Lanka*

*\*2021 information is presented only for STRs received from RIs and the general public.*

A significant number of STRs amounting to 1,083 was disseminated to relevant LEAs in 2021. A considerable portion of these STRs consists of suspicions related to overseas ATM withdrawals, drug deals and scams. These LEAs include Sri Lanka Police, Criminal Investigation Department (CID), Counter Terrorism and Investigation Division (CTID), Police Narcotic Bureau (PNB), Sri Lanka Customs, and Commission to Investigate Allegations of Bribery or Corruption (CIABOC).

**Figure 1.6**

**STRs Referred to LEAs**

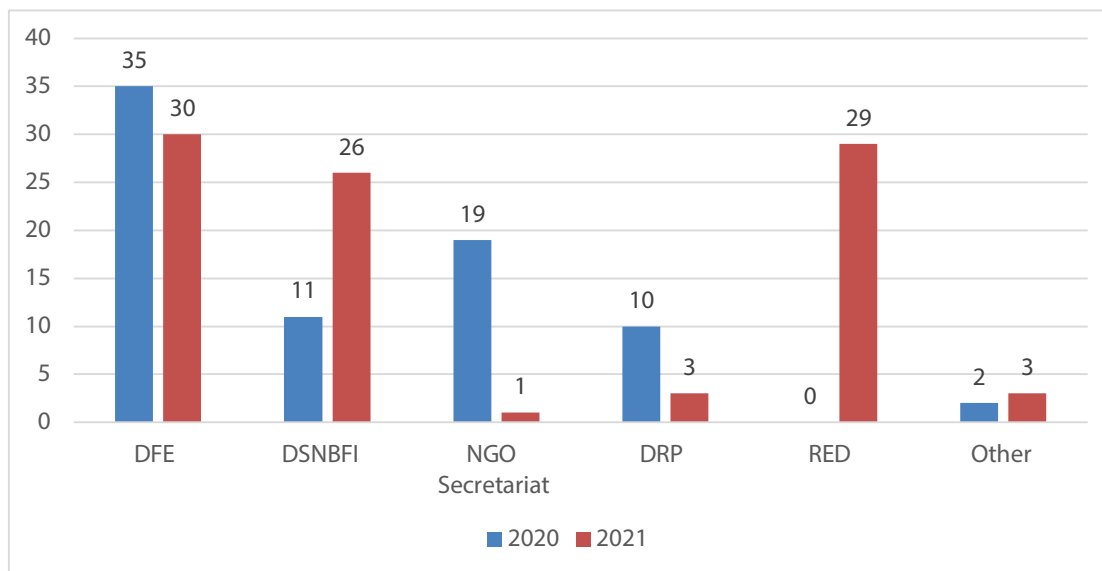


Source: Financial Intelligence Unit-Sri Lanka

\*2021 information is presented only for STRs received from RIs and the general public.

The FIU-Sri Lanka referred 88 STRs to RAs, namely the Department of Foreign Exchange (DFE), Department of Supervision of Non-Bank Financial Institutions (DSNBFI) and Bank Supervision Department (BSD) of the Central Bank of Sri Lanka (CBSL), the Department of Registration of Persons (DRP), the NGO Secretariat and the Securities, and Exchange Commission of Sri Lanka (SEC) for further investigations. The majority of the STRs, which were on suspicion of violation of foreign exchange regulations, were referred to the DFE. The number of STRs referred to the DSNBFI and Resolution and Enforcement Department (RED) has increased considerably due to enhanced awareness among RIs and the public about pyramid schemes and unauthorized deposit taking.

**Figure 1.7**  
**STRs Referred to RAs**



Source: Financial Intelligence Unit-Sri Lanka

\*2021 information is presented only for STRs received from RIs and the general public.

## 1.2 Facilitating Law Enforcement Agencies (LEAs)

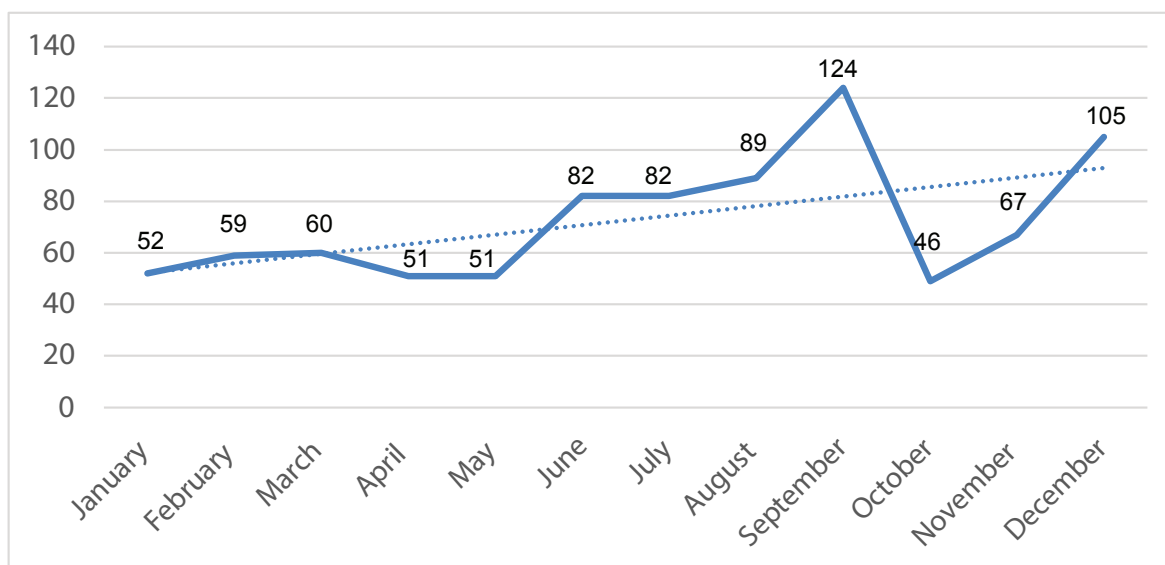
The FIU-Sri Lanka facilitates LEAs by providing them required financial information to effectively conduct their investigations related to ML/TF. These facilitations may either be relevant to ML/TF investigations initiated by the LEAs or investigations conducted based on STRs referred by the FIU-Sri Lanka. Exercising the powers vested on the FIU-Sri Lanka in terms of Section 15 (1) (b) of the FTRA and considering the MoU signed between the FIU-Sri Lanka and Sri Lanka Police in 2017, the FIU-Sri Lanka gathers financial information from RIs and disseminates to LEAs based on their information requirements.

LEAs submit Information Requests to the FIU-Sri Lanka in terms of the Section 15 (1) (a) and 15 (2) of the FTRA. These requests received from LEAs are considered as STRs and recorded in the LankaFin system prior to calling for information from respective RIs, till end of July 2021. However, with a view to expediting the entire process of fulfilling financial information requirements of LEAs, the FIU-Sri Lanka successfully initiated the live implementation of the goAML system, a system used by many countries in the context of AML/CFT, with effect from August 01, 2021. The goAML system enhances overall efficiency by providing a single platform to receive information requirements from LEAs, requests relevant information from RIs, collates all the information received from RIs, and disseminates it to LEAs.

During 2021, the FIU-Sri Lanka received 871 Information Requests from LEAs. A monthly breakdown of such requests is depicted in Figure 1.8 below. Causes for notable variations in the dispersion and deviations from the trendline as illustrated below are mainly due to work related arrangements associated with mobility restrictions imposed during the pandemic.

**Figure 1.8**

**No. of Information Requests Received from LEAs**

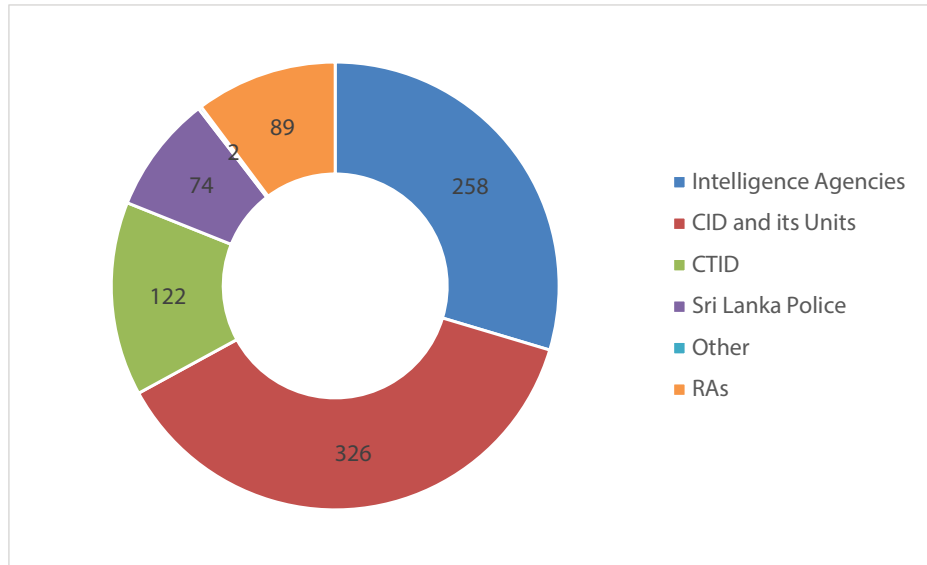


As per institutional categorization of the total Information Requests, more than one third are from the CID and other units fall under the purview of the CID such as Illegal Property or Assets Investigation Division (IPAID), Financial and Commercial Crimes Investigation Division (FCCID), Homicide and Organized Crimes Investigation Division (HOCID), etc. Secondly, Intelligence Agencies such as State Intelligence Service (SIS), Chief of National Intelligence (CNI), Directorate of Military Intelligence and Sri Lanka Navy Intelligence submitted 258 Information Requests. As a single entity, CTID submitted 122 Information Requests.

The 89 Information Requests submitted by RAs solely comprise of Information Requests submitted by the DSNBFI of CBSL relating to institutions/individuals engaged in unauthorized finance businesses. PNB, Special Task Force (STF), Regional Superintendent of Police Offices and Regional Police Stations submitted 74 Information Requests during the year. The other two Information Requests are from the Bureau of Prevention of Abuse of Children & Women and Sri Lanka Customs.

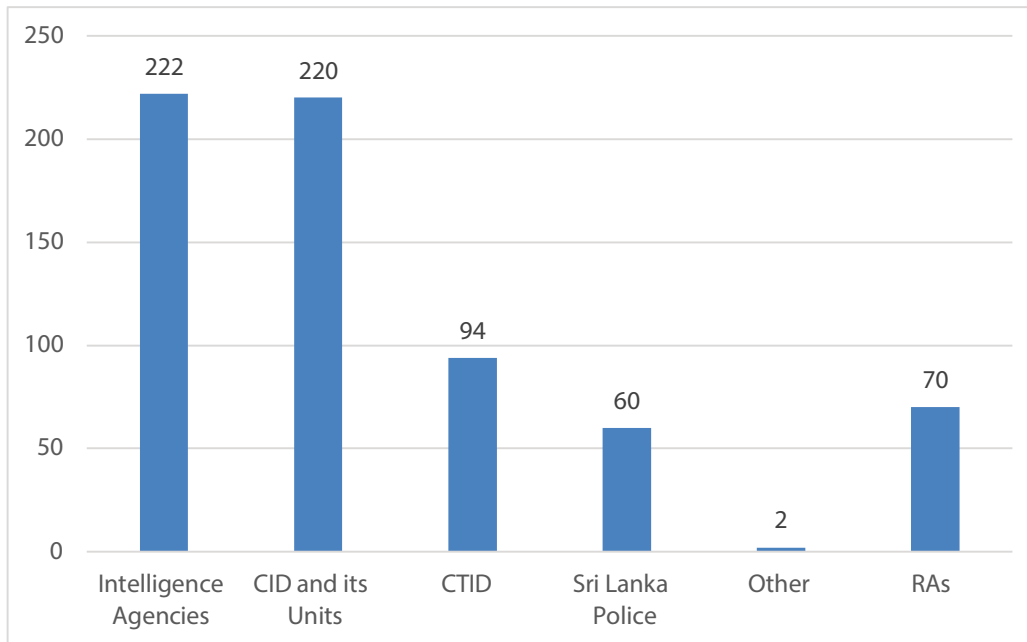


**Figure 1.9**  
**Information Requests Submitted by LEA/RAs**



During the year 2021, 668 Information Requests were facilitated by providing financial information including account details of the suspects and other parties involved with the case. Figure 2.1 illustrates recipients of such financial information.

**Figure 1.10**  
**Information Requests Facilitated**



Conforming to the powers vested with the FIU-Sri Lanka in terms of the FTRA, the FIU-Sri Lanka facilitates financial information requirements of LEAs only if the underlying offence is related either to ML/TF. With the purpose of streamlining the procedure of seeking financial information, the FIU-Sri Lanka issued relevant guidelines to LEAs with effect from 18 October 2021.

Information sharing, particularly, financial intelligence among government authorities and institutions who are involved in prevention, detection and investigation of ML/TF is vital to facilitate investigation and prosecution of persons suspected of committing and participating in ML/TF related activities. Further, exchanging financial intelligence with foreign counterparties is also crucial in combating illicit activities that have cross border links and networks. The FIU-Sri Lanka played a leading role in this mutually beneficial information sharing mechanism in 2021.

## 2.1 Domestic Cooperation

### 2.1.1 Competent Authorities

The FIU-Sri Lanka performs its key role of receiving, analysing and disseminating information on suspicious transactions relating to ML/TF or any other unlawful activity. Upon analysis of information received through STRs from RIs, LEAs, RAs and the general public, together with other relevant information obtained from various sources, the FIU-Sri Lanka disseminates the results to relevant competent authorities for further investigation or actions, where necessary. These competent authorities include Sri Lanka Police, CID, CTID, PNB, Sri Lanka Customs, CIABOC, SIS, Directorate of Military Intelligence (DMI), and MOD. Such competent authorities benefit from such information disseminated by the FIU-Sri Lanka to effectively perform their analysis and investigations of ML/TF activities and predicate offences, and it provides the basis for the prosecution of persons, where necessary. Statistics related to dissemination of STRs to competent authorities are included in Chapter 1.

### 2.1.2 Regulatory Authorities

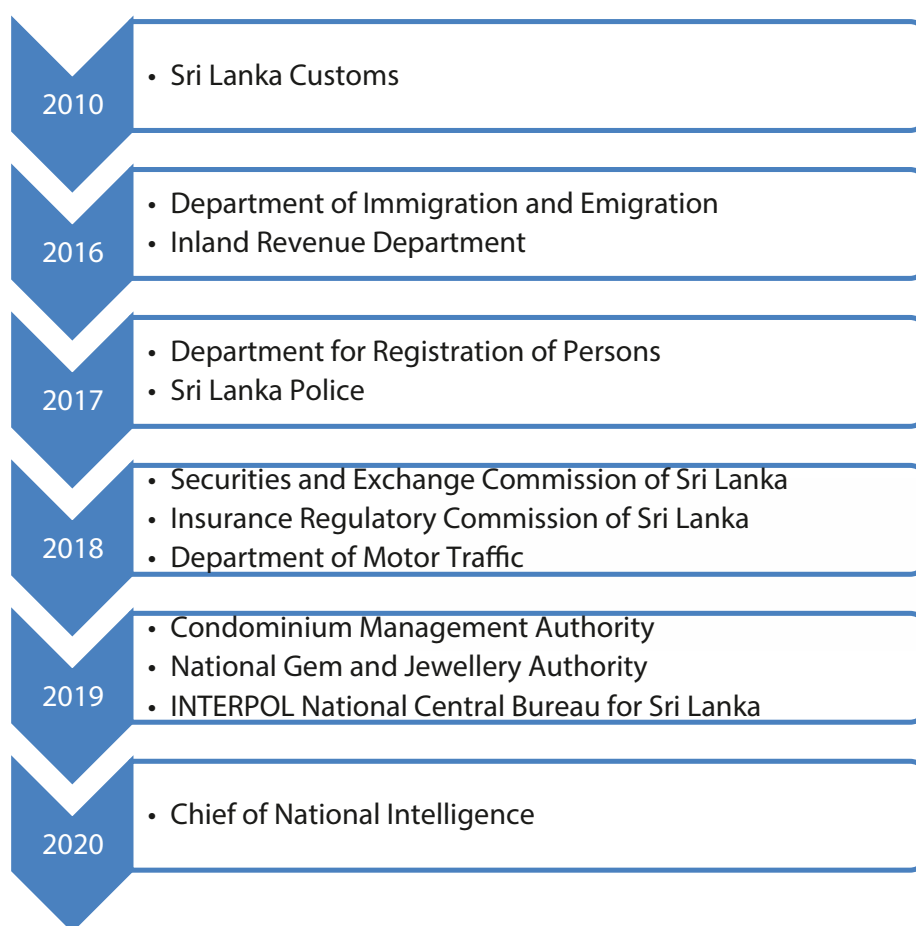
The FIU-Sri Lanka disseminates results of the analyses of STRs to RAs, namely the DFE, DSNBFI and BSD of the CBSL, DRP, the NGO Secretariat and SEC for further investigations. Statistics related to dissemination of STRs to competent authorities are included in Chapter 1.

### 2.1.3 Memoranda of Understanding (MOUs) with Domestic Agencies

Coordination and cooperation between the FIU-Sri Lanka and relevant domestic agencies are imperative to combat complex ML/TF activities. The FIU-Sri Lanka is vested with the legal authority by Section 15 (1) (r) of the FTRA, to enter into agreements or arrangements with any domestic government institution or agency with respect to the exchange of information. By the end of 2021, the FIU-Sri Lanka had entered into Memoranda of Understanding (MOUs) with 12 domestic agencies to exchange information as illustrated in Figure 2.1 below. The FIU- Sri Lanka has also initiated actions to sign an MOU with the Commission to Investigate Allegations of Bribery or Corruption.

**Figure 2.1**

#### **MOUs with Domestic Agencies as at December 31, 2021**



*Source: Financial Intelligence Unit-Sri Lanka*

### 2.1.4 Other Forms of Domestic Cooperation

The FIU-Sri Lanka continued to assist several stakeholders on legislative amendments aiming at strengthening AML/CFT of Sri Lanka. Accordingly, the FIU-Sri Lanka has taken the lead in introducing amendments to the Companies Act, No. 7 of 2007. Furthermore, the FIU- Sri

Lanka was also involved in discussions related to introducing amendments to the Voluntary Social Service Organizations (Registration and Supervision) Act, No. 31 of 1980, and the FIU-Sri Lanka also played a significant role in the process of introducing new legislation on Proceeds of Crime.

A meeting of the AML/CFT National Coordinating Committee (NCC) was held on April 05, 2021 chaired by the Governor as the Chairman, with the participation of all members amidst the COVID-19 pandemic. The second NCC Meeting scheduled for the month of November 2021 had to be postponed due to unavoidable circumstances.

The FIU-Sri Lanka has developed institution-wise action plans with the objective of increasing the effective implementation of AML/CFT measures by all relevant stakeholders based on recommended actions of the 2014/15 Mutual evaluation and 11 immediate outcomes. These action plans were forwarded to the stakeholders in April 2021 for implementation. The first round of meetings to ascertain the progress meetings was held during the months of October/November 2021 and all stakeholders have assured that they are in the process of implementing the said action plans.

Further, the FIU-Sri Lanka is a permanent member of the Targeted Financial Sanctions (TFS) Committee headed by the Secretary of Defence, in his capacity as the Competent Authority which is the primary mechanism for inter-agency coordination for effective implementation of the United Nations Security Council Resolutions (UNSCRs) in Sri Lanka.

## **2.2 International Cooperation**

### **2.2.1 Exchange of Information with Counterpart Financial Intelligence Units (FIUs)**

Effective sharing of financial intelligence, both domestically and internationally, is one of the cornerstones of a well-functioning AML/CFT framework. As ML/TF offences may involve cross border activities, sharing of information with counterpart FIUs is vital. The FIU-Sri Lanka is empowered by Sections 15 (1) (q), 16 and 17 of the FTRA, to cooperate with institutions and agencies of a foreign state for the investigation or prosecution of ML/TF. The information shared in this manner is used only for intelligence purposes.

During the year 2021, the FIU-Sri Lanka made 49 requests from the Egmont Group member FIUs to share information related to ongoing investigations. At the same time, the FIU-Sri Lanka responded to 19 requests from various counterpart FIUs including FIUs of the Dominican Republic, Greece, India, Japan, Lithuania, Pakistan, Philippines, Singapore, Syria, and Turkey to share information. Some counterpart FIUs facilitated certain investigations of LEAs of Sri Lanka by providing necessary information. Table 2.1 depicts the information requests made and information requests received by the FIU-Sri Lanka from 2016 to 2021.

Further, the FIU-Sri Lanka carried out a survey among 21 countries on legislative framework available within each jurisdiction on informal money remittance systems such as Hawala/Undial/Hundi. The main aim of the survey was to gather country experience in terms of legalizing these informal money remitters and several countries provided responses to the survey.

**Table 2.1**  
**Sharing of Information with Foreign Counterpart FIUs**

	2017	2018	2019	2020	2021
Requests Received	50	24	40	15	19
Requests Made	54	70	58	35	49

### 2.2.2 Memoranda of Understanding (MOUs) with Counterpart FIUs

According to Sections 16 and 17 of the FTRA, the FIU-Sri Lanka can enter into agreements for the exchange of information regularly with any institution or agency of a foreign state that has powers and duties similar to those of the FIU-Sri Lanka, with the approval of the Minister of Finance. During the year 2021, the FIU-Sri Lanka initiated negotiations to sign MOUs with several counterpart FIUs, namely those of Lesotho and Guatemala. The MOUs signed by the FIU-Sri Lanka with foreign counterparts as at December 31, 2021 are as follows:

**Figure 2.2**

**MOUs with Foreign Counterpart FIUs as at December 31, 2021**

2008 - 2009	2010 - 2011	2012 - 2013	2014 - 2016	2017 - 2021
Malaysia Afghanistan Republic of Korea Indonesia Nepal Philippines Cambodia	India Australia Belgium Solomon Island Bangladesh South Africa Fiji Canada Slovenia	USA Mongolia Russia Saudi Arabia Japan Lebanon Costa Rica Denmark	Albania Peru Myanmar Kyrgyz Republic Panama Ukraine Israel Singapore	Thailand Bhutan China Trinidad & Tobago Qatar Papua New Guinea Maldives

*Source: Financial Intelligence Unit-Sri Lanka*

### 2.2.3 The Asia Pacific Group on Money Laundering (APG)

The APG is an inter-governmental organization focused on ensuring that its members effectively implement the international standards against ML/TF and proliferation of financing related to weapons of mass destruction. The APG is a part of the global network of similar bodies, referred to as Financial Action Task Force-styled Regional Bodies (FSRBs) and

is the largest in terms of the membership and the geographical size. The APG consists of 41 member jurisdictions, and Sri Lanka has been a member of the APG since its establishment in 1997.

The 23rd Annual Meeting of the APG was held virtually during 27 - 29 July 2021 amidst the COVID-19 pandemic and related travel restrictions. Further, the APG held a special plenary meeting virtually on 18, November 2021 mainly to discuss and adopt the Mutual Evaluation Report (MER) of Vietnam. The FIU-Sri Lanka participated in both plenary discussions and several Mutual Evaluation Committee (MEC) Meetings held during the year, mainly to discuss the members' MERs and Follow-up Reports (FURs) including the 6th FUR of Sri Lanka.

As per the APG follow-up process, Sri Lanka submitted the annual progress report on technical compliance on June 01, 2021 and it was taken up for the discussion at the APG MEC Meeting held in September 2021. Sri Lanka requested upgrades to Recommendation 32 on 'Cash Couriers' and Recommendation 40 on 'Other Forms of International Cooperation', which were rated as Partially Compliant in 2015. The 6th FUR on Sri Lanka was discussed and adopted by the membership during the MEC Meeting held in September 2021 with upgraded rating for Recommendation 32 from Partially Compliant to Largely Compliant (LC). The current technical compliance ratings for Sri Lanka are given in Table 2.2.

**Table 2.2**  
**Current Level of Sri Lanka's Technical Compliance Ratings for FATF 40 Recommendations**

Level of Compliance	At the MER Adoption in July 2015	After Re-rating in 2016	After Re-rating in 2018	After Re-rating in 2019	After Re-rating in 2020	After Re-rating in 2021
<b>Compliant (C)</b>	5	5	6	7	7	7
<b>Largely Compliant (LC)</b>	7	16	21	24	24	25
<b>Partially Compliant (PC)</b>	16	13	8	7	8	7
<b>Non-Compliant (NC)</b>	12	6	5	2	1	1
	40	40	40	40	40	40

#### 2.2.4 Egmont Group

The Egmont Group is an international body with membership of 166 FIUs around the world, and it provides its members a forum to exchange information confidentially to combat ML/TF. This international network provides a platform for FIUs to improve support to their respective governments in the fight against ML/TF and other financial crimes. The Egmont Group's secure internet system, the Egmont Secure Web, is the trusted gateway for sharing financial information domestically and internationally in accordance with global AML/CFT standards.

The FIU-Sri Lanka has been a member of the Egmont Group since May 2009 and continues to share financial intelligence with its foreign counterparts effectively. The officials of the FIU-Sri Lanka have been actively participating in the Annual Plenary and various working group meetings of the Egmont Group since 2009. Officials of the FIU-Sri Lanka also participated in the desk-based review of the FIU-Malawi for an Egmont Group Trigger III review. The FIU-Sri Lanka also participated in the Egmont Working Group discussions and the Head of FIUs meeting held virtually in July 2021.

### **2.2.5 Financial Action Task Force (FATF)**

The FATF is an intergovernmental organization, established in 1989, that develops international standards to curb ML/TF and counter the financing of weapons of mass destruction. As the AML/CFT policy setter, the FATF monitors the progress of its members in implementing necessary measures, reviews ML/TF techniques and countermeasures, and promotes the adoption and implementation of appropriate measures globally. In collaboration with other international stakeholders, the FATF works to identify national-level vulnerabilities with the aim of protecting the international financial system from misuse.

## **2.3 Technical Assistance (TA) through International Cooperation**

### **2.3.1 US Department of Treasury**

Kevin Whelan, adviser from the Office of Technical Assistance (OTA) Economic Crimes Team of the US Department of Treasury, acted as the FIU-Sri Lanka's Resident Consultant from May 2017 to September 2021. During his time as the FIU resident advisor, Mr. Whelan provided expert advice mainly in the areas of improving information technology infrastructure of the LankaFIN and goAML systems, assisting in the review of Guidelines issued by the FIU-Sri Lanka such as Identification of Beneficial Ownership, STR Reporting, Politically Exposed Persons (PEPs), Regulatory Sandbox, eKYC, etc, while also assisting in improving the analytical capabilities of the FIU-Sri Lanka and offering expert advice in the areas of mapping AML/CFT legal obligations alongside improving information technological requirements. Mr. Whelan also conducted several awareness sessions for the CBSL Monetary Board, officers of FIs/DNFBPs and law enforcement officers on the identification and use of beneficial ownership information, STR reporting, investigative techniques, etc.

### **2.3.2 The Asia Pacific Group on Money Laundering (APG) Regional Webinar Series - Designated Non-Financial Businesses and Professions (DNFBPs) Regulation: Financial Action Task Force (FATF) International Standards and Implementation**

The FIU-Sri Lanka participated in the webinar series conducted by the APG in partnership with Malaysia with the objective of developing a common platform that will allow APG

members to continuously share their supervision expertise and experiences related to DNFBPs, by addressing common challenges and gaps on AML/CFT measures, as well as providing DNFBP supervisors the opportunity for ongoing engagement with international counterparts. During the first webinar held in April 2021 the FIU-Sri Lanka shared our experience in implementation, best practices and challenges in developing the DNFBP regulatory net in Sri Lanka.

### **2.3.3 Other Technical Assistance (TA) Projects**

On invitation of World Bank TA Team to Sri Lanka, the FIU-Sri Lanka conducted a session to share country experience in effective implementation of DNFBP supervision in Sri Lanka with Zimbabwe authorities.



## 3.1 Supervision of Financial Institutions

### 3.1.1 Legal Background of AML/CFT Supervision of Financial Institutions (FIs)

The FIU-Sri Lanka, with the authority vested in it under Section 15(1)(e) read together with Section 18 of the FTRA, carries out supervision of the FIs listed under Section 33 of the FTRA to monitor the institutional AML/CFT compliance. The FIs include Licensed Commercial Banks (LCBs), Licensed Specialized Banks (LSBs), LFCs, ICs, SBs, MVTS providers and Registered Dealers (RDs). Accordingly, as the AML/CFT focal point for the country, the FIU-Sri Lanka adopts the following measures in supervising FIs.

- conducting ML/TF offsite risk assessments
- conducting AML/CFT examinations (risk-based examinations, follow-up examinations and spot examinations)
- taking regulatory actions on non-compliances
- conducting meetings with FIs
- implementing timely measures as and when required such as conducting thematic reviews.

### 3.1.2 ML/TF Risk Assessment

The FIU-Sri Lanka conducts ML/TF risk assessments of FIs to identify ML/TF risk of individual FIs annually on an offsite basis with the use of a risk assessment tool. The results of the tool are used to develop the on-site supervisory plan for the coming year.

#### 3.1.2.1 Risk Assessment Tool

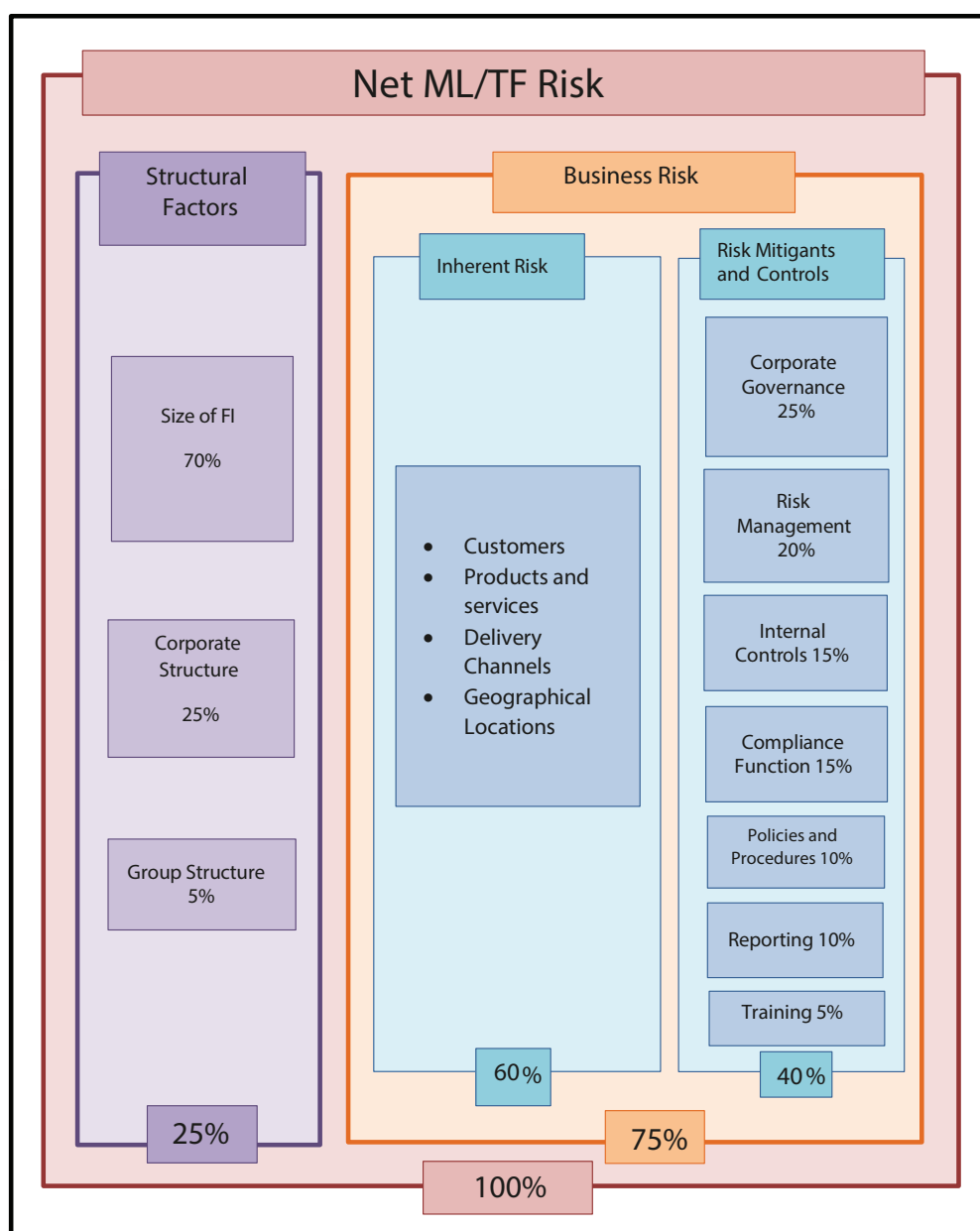
The FIU-Sri Lanka uses a risk assessment tool to identify the ML/TF risks of individual FIs which was developed in 2017 in collaboration with the technical assistance team of the International Monetary Fund (IMF). During the visit of the IMF team to Sri Lanka in 2019, the tool was further improved to enhance the quality of the results. The tool assesses the ML/TF risk of individual FIs based on a number of risk factors and weights determined by the FIU-Sri Lanka based on its knowledge and judgement as the AML/CFT supervisor.

The net ML/TF risk of the FI is evaluated in terms of structural factors and business risk. Size of the FI, corporate structure, and the group structure are considered as major components of structural factors, while inherent risk (customers, products and services, delivery channels, geographical locations), and risk mitigates and controls (evaluated using corporate governance, policies and procedures, risk management, internal controls, compliance function, training, and reporting in terms of the provisions of the FTRA) are considered to assess business risk.

In the overall risk assessment, risk posed by structural factors is allocated a weight of 25% while business risk is allocated a weight of 75%.

**Figure 3.1**

**The Composition of the Risk Tool: Risk Factors and Weightage**



Source: Financial Intelligence Unit - Sri Lanka

### 3.1.2.2 ML/TF Risk Assessment in 2021

The FIU-Sri Lanka performs ML/TF risk assessment for the banking and finance company sectors on an annual basis to develop the on-site supervisory plan for the next year using the risk assessment tool described in section 3.1.2.1. Apart from the above, SEC and IRCSL conduct ML/TF risk assessments of the individual institutions of securities and insurance sectors, respectively.

The information related to structural factors and inherent risk of FIs are collected through a data collection form while the information on risk-mitigating measures taken by the FIs are collected through an AML/CFT questionnaire designed and improved by the FIU-Sri Lanka to be convenient and compatible with the risk assessment tool.

In 2021, the FIU-Sri Lanka conducted ML/TF risk assessments for 66 individual institutions from the banking and the finance company sectors by disseminating the data collection form and the AML/CFT questionnaire.

**Table 3.1**

**Number of ML/TF Risk Assessments Conducted During 2017-2021**

<b>Year</b>	<b>No. of ML/TF risk assessments</b>
2017	78
2018	75
2019	70
2020	69
2021	66

*Source: Financial Intelligence Unit - Sri Lanka*

The reason for the gradual reduction of the number of ML/TF risk assessments over the past 5 year period is the reduction of RIs due to closures of business operations, mergers with other institutions and cancellation of licenses of FIs issued by the CBSL.

### 3.1.3 AML/CFT Examinations

#### 3.1.3.1 Risk-based Onsite Examinations Conducted in 2021

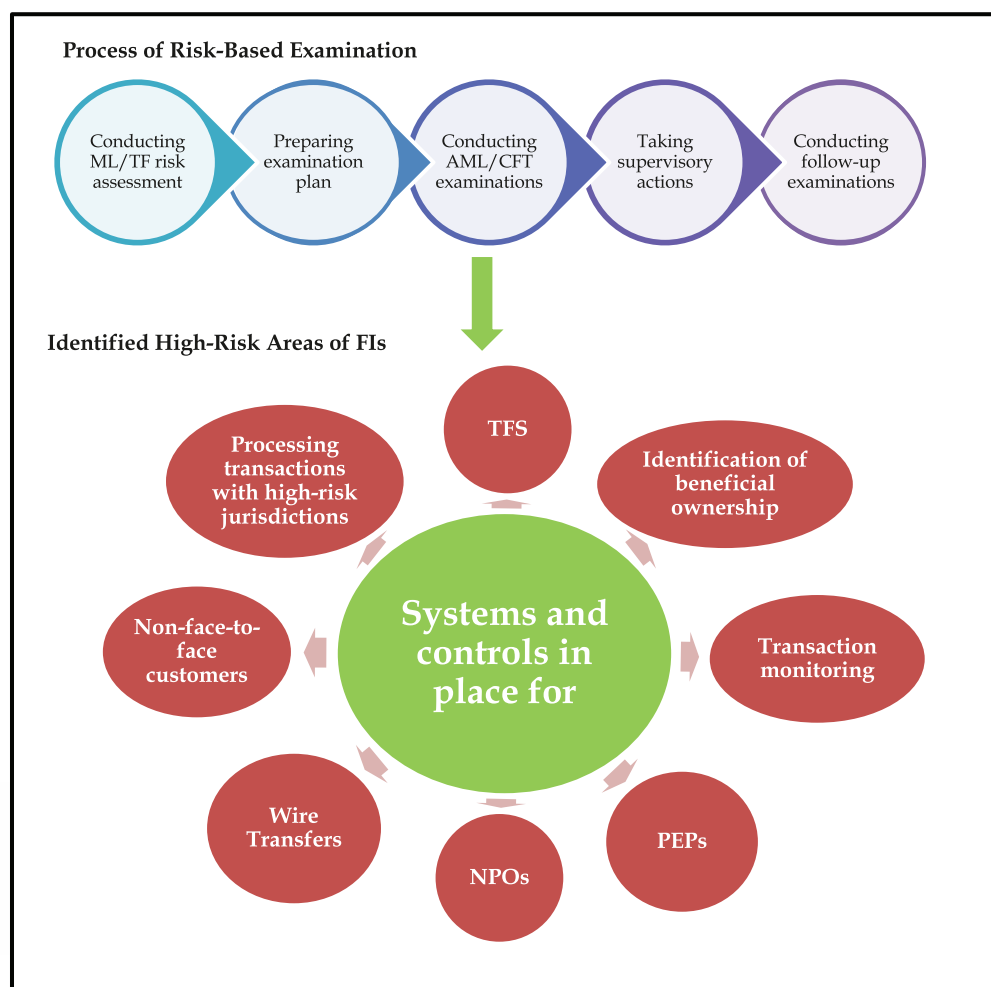
The FIU-Sri Lanka has implemented a Risk-Based Approach (RBA) for AML/CFT supervision since 2017. The RBA allows to allocate resources efficiently based on the risk of the financial sector. Accordingly, as stated in 3.1.2, ML/TF risk assessment is conducted as the initial step of effective risk-based supervision.

Based on the results of the ML/TF risk assessment, an annual risk-based examination plan for banking and finance company sectors is prepared and resources are allocated accordingly.

Once the resources are allocated according to the on-site examination plan, on-site examinations on FIs are conducted based on the following areas identified as high-risk according to FATF standards.

**Figure 3.2**

**Process of Risk-Based Examination and Identified High-Risk Areas of FIs**



Source: Financial Intelligence Unit – Sri Lanka

**Table 3.2**

**Number of Onsite Examinations Conducted During 2017-2021**

Type of FI	2017	2018	2019	2020	2021
LCBs	05	13	13	01	01
LSBs	-	02	03	-	-
LFCs	16	04	11	06	-
MVTS providers	-	-	01	-	01
<b>Total</b>	<b>21</b>	<b>19</b>	<b>28</b>	<b>07</b>	<b>02</b>

Source: Financial Intelligence Unit - Sri Lanka

The number of on-site examinations conducted during 2021 had to be decreased due to the restrictions imposed during the COVID-19 pandemic situation in Sri Lanka.

Accordingly, the FIU-Sri Lanka conducted 2 risk-based on-site examinations on an LCB and on a MVTS provider. However, the on-site examination started on the LCB had to be continued as a remote examination due to the pandemic.

### 3.1.3.2 Follow-up Examinations Conducted in 2021

In addition to risk-based on-site examinations, the FIU-Sri Lanka conducts follow-up examinations to evaluate the progress made by the FI. The FIU-Sri Lanka has performed the follow-up examination procedure since 2019.

Accordingly, the FIU-Sri Lanka commenced 4 offsite follow-up examinations during 2021 on 2 LCBs and 2 LSBs.

**Table 3.3**  
**Number of Follow-up Examinations Conducted During 2019 and 2021**

Type of FI	2019	2020	2021
LCBs	02	07	02
LSBs	02	-	02
<b>Total</b>	<b>04</b>	<b>07</b>	<b>04</b>

*Source: Financial Intelligence Unit - Sri Lanka*

### 3.1.3.3 Spot Examinations Conducted in 2021

Apart from the risk-based examinations and follow-up examinations, spot examinations are also conducted by the FIU-Sri Lanka based on special circumstances. Accordingly, 7 spot examinations were conducted during 2021 on 2 LCBs and 5 LFCs in relation to UNSCR matters.

**Table 3.4**  
**Number of Spot Examinations Conducted During 2020 and 2021**

Type of FI	2020	2021
LCBs	10	02
LSBs	01	-
LFCs	04	05
MVTS providers	01	-
<b>Total</b>	<b>16</b>	<b>07</b>

*Source: Financial Intelligence Unit - Sri Lanka*

### 3.1.3.4 Joint Examinations Conducted in 2021

The FIU-Sri Lanka provides resources/technical assistance to conduct joint supervision for the securities and insurance sectors as per the supervision plans prepared by SEC and IRCSL respectively, for each sector.

During 2021, the FIU-Sri Lanka widened its scope of joint examination to over the banking sector with the collaboration of BSD.

Accordingly, the FIU conducted examinations on 4 LCBs and 3 ICs jointly with the BSD and IRCSL respectively, in 2021. Examinations conducted on 3 ICs were carried out as offsite examinations.

**Table 3.5**  
**Joint Supervisions with Regulators During 2018 - 2021**

Joint Supervision with	2018	2019	2020	2021
BSD	-	-	-	04
SEC	01	05	02	-
IRC SL	01	03	02	03
<b>Total</b>	<b>02</b>	<b>08</b>	<b>04</b>	<b>07</b>

*Source: Financial Intelligence Unit - Sri Lanka*

### 3.1.4 Supervisory Actions Taken in 2021

FATF Recommendations 26, 27, 34 and 35 are mainly focused on implementing legal provisions effectively in order to improve the overall AML/CFT framework of FIs and overall supervisory effectiveness of the country.

Once an examination is completed, a comprehensive report including the scope and examination findings is submitted to the Director, FIU-Sri Lanka with recommended actions for addressing the identified deficiencies at the examination. Then the findings are communicated to the respective FI. The FIU-Sri Lanka takes two types of actions based on the findings of the on-site examinations:

#### (a) Issuing a letter requesting to rectify the deficiencies

*If the deficiencies are not significant and they do not breach the provisions of the FTRA, the FIU-Sri Lanka communicates the observations to the Chief Executive Officer (CEO) of the particular FI and requests them to take actions to rectify the deficiencies with immediate effect or within a stipulated time frame.*

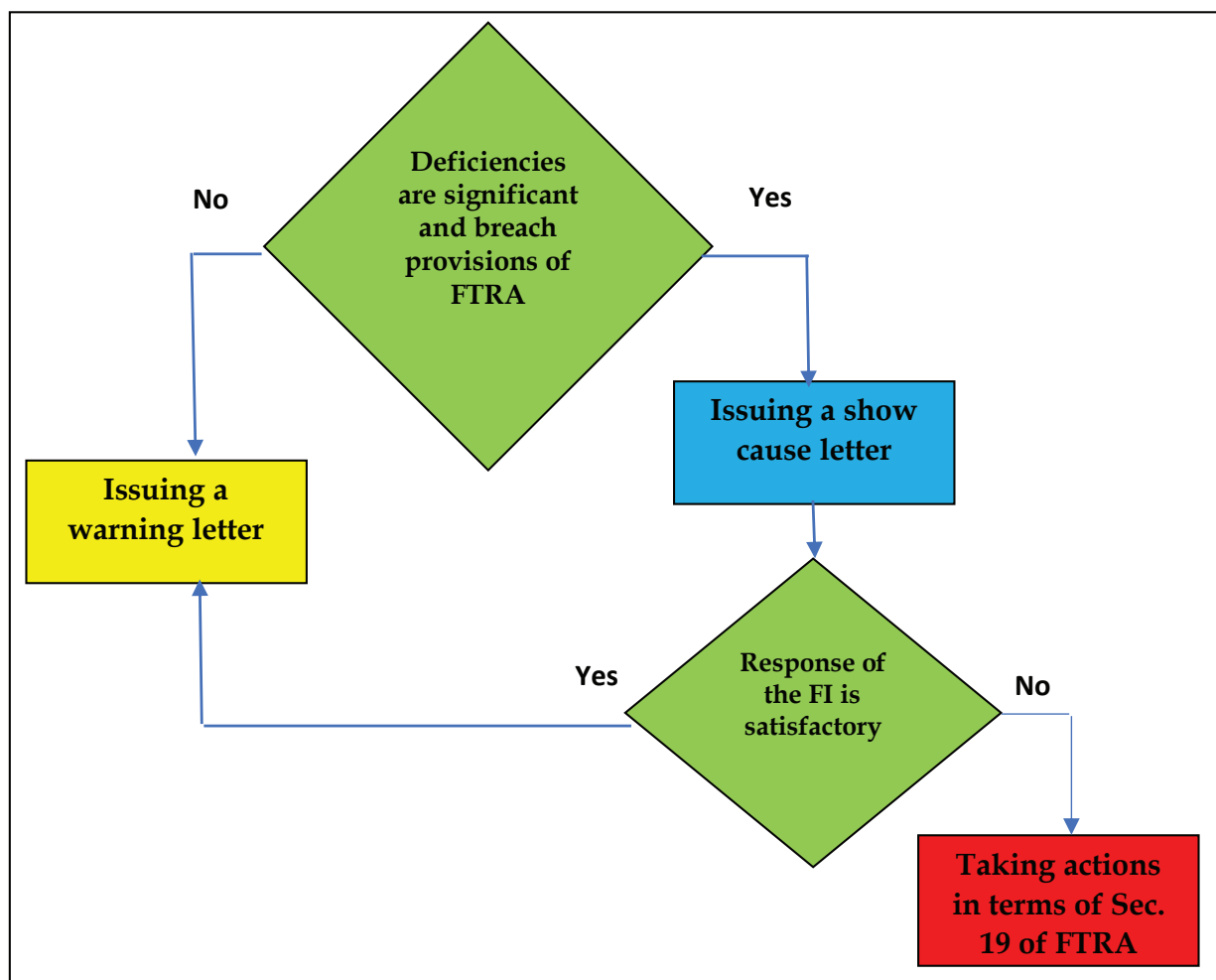
#### (b) Imposing a penalty

*If the deficiencies are significant and involved instances of non-compliance with the provisions of the FTRA, the FIU-Sri Lanka issues a show-cause letter requesting the CEO to explain*

*the reasons as to why the institution has failed to comply with the provisions of FTRA. If the response is not satisfactory, the FIU-Sri Lanka will take action in terms of Section 19 of the FTRA. Accordingly, proportionate and dissuasive sanctions are imposed against FIs who fail to comply with AML/CFT requirements.*

These actions are taken pursuant to a discussion by the FIU-Sri Lanka's Internal Committee that assesses the facts leading to the non-compliance revealed from the onsite/offsite exercises. The final decision for a penalty or warning letter would be based on the unanimous decision arrived upon by the Committee.

**Figure 3.3**  
**Action-Taking on Findings of Examinations**



*Source: Financial Intelligence Unit - Sri Lanka*

**Table 3.6**  
**Regulatory Actions Taken by FIU-Sri Lanka on FIs During 2018-2021**

Actions Taken	2018	2019	2020	2021
Warning letters	15	29	17	05
Follow-up warning letters	-	03	04	01
Show Cause letters	07	07	08	05
Penalties Imposed	06	03	05	07

*Source: Financial Intelligence Unit - Sri Lanka*

**Table 3.7**  
**Details of Financial Penalties Imposed During 2018 - 2021**

Year	Type of FI	Violation	Amount (Rs.)
2018	LFC	Section 2 of the FTRA and Customer Due Diligence (CDD) Rules for FIs	4,000,000.00
	LCB	Section 2 of the FTRA and CDD Rules for FIs	1,000,000.00
	MVTS Provider	Section 7 of the FTRA	500,000.00
	LCB	Section 7 of the FTRA	1,000,000.00
	LCB	Section 7 of the FTRA	1,500,000.00
	LCB	Rule 95 of the CDD Rules for FIs	500,000.00
<b>Total</b>			<b>8,500,000.00</b>
2019	LCB	Rule 47 (c), Rule 59 (b) and Rule 95 of the CDD Rule for FIs	3,000,000.00
	LCB	Section 6 of the FTRA	1,000,000.00
	LFC	Rule 95 of the CDD Rule for FIs	1,000,000.00
<b>Total</b>			<b>5,000,000.00</b>
2020	LFC	Rule 95 of the CDD Rule for FIs	500,000.00
	LFC	Rule 95 of the CDD Rule for FIs	500,000.00
	LFC	Rule 95 of the CDD Rule for FIs	300,000.00
	LFC	Rule 95 of the CDD Rule for FIs	1,000,000.00
	LFC	Rule 95 of the CDD Rule for FIs	1,000,000.00
<b>Total</b>			<b>3,300,000.00</b>
2021	LFC	Rule 95 of the CDD Rule for FIs	1,000,000.00
	LCB	Section 5 & 7 of the FTRA, Rules 27, 91, 96, 37, 38, 7, 8, 9, 27 (2) of the CDD Rule for FIs	3,000,000.00
	LCB	Rule 95 of the CDD Rule for FIs	2,000,000.00
	LCB	Section 5(b), 14 (1) (b) (iii), 15 (3) of the FTRA, Rules 7,8,9,10, 27(2) of the CDD Rule for FIs	1,000,000.00
	LFC	Rule 95 of the CDD Rule for FIs	1,000,000.00
	LCB	Section 4(4), 14(1), 14(1) (b) (iii), 15 (3) of the FTRA, Rules 7,8,9,10, 27(2) of the CDD Rule for FIs	500,000.00
	LFC	Rule 95 of the CDD Rule for FIs	500,000.00
	LFC	Rule 95 of the CDD Rule for FIs	1,000,000.00
	LFC	Rule 95 of the CDD Rule for FIs	500,000.00
	<b>Total</b>		

*Source: Financial Intelligence Unit - Sri Lanka*



### 3.1.5 Meetings Conducted with Financial Institutions (FIs) in 2021

The FIU-Sri Lanka organizes follow-up on-site meetings with top management of FIs when the examiners are of the view that the management needs to be more aware of the deficiencies identified in that FI. Meetings are conducted with key management personnel of FIs to discuss the way forward and their readiness to implement corrective measures suggested.

The FIU-Sri Lanka conducted follow-up meetings with 3 LCBs during 2021 to discuss the progress of AML/CFT compliance.

**Table 3.8**  
**Number of Follow-up Meetings Had with FIs During 2018 – 2021**

Type of FI	2018	2019	2020	2021
LCBs	01	05	-	03
LSBs	-	01	-	-
LFCs	-	01	-	-
<b>Total</b>	<b>01</b>	<b>07</b>	<b>-</b>	<b>03</b>

*Source: Financial Intelligence Unit - Sri Lanka*

### 3.1.6 Thematic Reviews Conducted in 2021

In 2020, the FIU-Sri Lanka commenced conducting thematic reviews to assess the overall compliance of the industry or selected FIs with different AML/CFT requirements.

During 2021, the FIU-Sri Lanka conducted 5 thematic reviews of FIs on several AML/CFT areas with emerging/increasing risks.

**Table 3.9**  
**Thematic Reviews Conducted During 2020 – 2021**

Year	Area of the Thematic Review	Type of FIs Covered
2020	Screening, Monitoring of customer transactions and Enhanced Due Diligence (EDD) of Politically Exposed Persons (PEPs)	LFCs
	Identification of Virtual Asset Service Providers (VASPs) in Sri Lanka	LCBs, LSBs, LFCs
	Off-line Debit card transactions	Selected banks

	Details of branches, procedures on identification & reporting of suspicious transactions of local branches open for serving customers outside normal working days / normal operating hours and details of ATM/Cash Recycle Machines/Cash Deposit Machines	LCBs, LSBs, LFCs
2021	Screening, monitoring of customer transactions and EDD of PEPs	LCBs, LSBs
	Database Integration with AML/CFT System and Digital Online Platforms of Licensed Banks and Licensed Finance Companies	LCBs, LSBs, LFCs
	Responsibilities of Board of Directors of Licensed Banks and Licensed Finance Companies towards AML/CFT	LCBs, LSBs, LFCs
	ATM withdrawals	Selected banks

*Source: Financial Intelligence Unit - Sri Lanka*

### 3.1.7 Measures Taken to Strengthen Institutional Compliance and Create Public Awareness in 2021

The FIU-Sri Lanka took several measures to strengthen the institutional compliance of the FIs sector and to create public awareness on AML/CFT aspects of FIs.

- a) 4 press releases were issued in 2021 on the administrative penalties imposed by the FIU-Sri Lanka.
- b) 4 newspaper/web advertisements were published to raise public awareness on CDD requirements and informal money transfer channels.
- c) 2 awareness programmes (a seminar on ‘Sanctioning, Terrorist Financing and Non-Governmental Organizations’ and a high-level web conference on ‘Creating a Culture of AML/CFT Compliance’) were conducted for the Boards of Directors (BODs) and Key Management Personnel of FIs.
- d) 1 guideline was issued to FIs on CCTV operations for AML/CFT purposes.

### 3.1.8 Way Forward

The FIU-Sri Lanka intends to continue the supervisory activities even under the prevailing situation which creates difficulties for conducting on-site supervisions. Further, the FIU-Sri Lanka will consider the unique set of challenges faced by FIs due to the non-face-to-face banking relationships.

The FIU-Sri Lanka will be focusing on conducting AML/CFT supervisions while streamlining the joint supervision procedures with the regulators of FIs.

Further, FIU-Sri Lanka is planning to conduct several awareness sessions to enhance

awareness among FIs on improving the compliance level.

Apart from the above, the FIU-Sri Lanka is planning to enhance its scope of supervision to Primary Dealers and Money Changers in the future.

## **3.2 Supervision of Designated Non-Finance Businesses and Professions (DNFBPs)**

### **3.2.1 Introduction**

As per Section 33 of the FTRA, DNFBPs are included in the definition of 'Institutions' and therefore are required to comply with the provisions of the FTRA. Currently, casinos, real estate agents, dealers in precious metals and precious and semi-precious stones (gem and jewellery dealers), lawyers, notaries and other independent legal professionals, accountants and trusts or company service providers (TCSPs) are supervised by the FIU-Sri Lanka as DNFBPs in Sri Lanka.

In terms of Section 15(1)(e) read with Section 18 of the FTRA, the FIU-Sri Lanka is empowered to conduct onsite and offsite supervision to ensure that Institutions comply with Rules, Regulations and Guidelines issued under the FTRA.

### **3.2.2 Risk-Based Supervision of DNFBPs**

Following the issuance of the CDD Rules for DNFBPs in 2018, the FIU-Sri Lanka undertakes AML/CFT supervision of DNFBPs under the RBA since January 2019. The supervision process of DNFBPs constitutes offsite ML/TF risk assessment, risk-based onsite examinations, offsite thematic reviews, spot examinations, and follow-up examinations.

Even though a risk-based onsite examination plan for the year 2021 was devised, the FIU-Sri Lanka was unable to carry out the onsite examinations as planned due to the COVID-19 pandemic situation that prevailed in the country. This situation resulted from the temporary closure of some DNFBPs, downturn of their business operations, restrictions on working hours and workforce, restrictions on geographically dispersed activities, etc. which, in turn, affected the onsite supervision examinations of the FIU-Sri Lanka. To compensate for this situation, the FIU-Sri Lanka conducted more offsite supervision in the form of thematic reviews for all DNFBP Institutions.

#### **a) Offsite Thematic Review Questionnaires**

The FIU-Sri Lanka conducted two offsite thematic review assessments in the second and third quarters of 2021 to ensure the following DNFBPs' compliance with AML/CFT obligations.

**Table 3.1****Number of DNFBPs Registered with the FIU-Sri Lanka (as at 31.12.2021)**

Sector	No. of DNFBPs
Gem & Jewellery	187
Real Estate	162
Casinos	03
Accountants & TCSPs	13
Lawyers & Notaries	11
<b>Total</b>	<b>376</b>

*Source: Financial Intelligence Unit-Sri Lanka*

The first offsite thematic review questionnaire on the compliance of Enhanced Customer Due Diligence (ECDD), PEPs, STRs and UNSCRs was circulated to all DNFBPs registered with the FIU-Sri Lanka in May 2021 to identify whether there were any compliance lapses in the sector.

Based on the responses to the offsite thematic review questionnaires submitted by the DNFBPs, the FIU-Sri Lanka conducted a sector wise comprehensive analysis on the compliance of ECDD, PEPs, STRs and UNSCRs.

The second offsite thematic review was conducted in August 2021 with a view to assessing the risk management systems/procedures of DNFBPs in Sri Lanka. The questionnaire covered the aspects of the ML/TF Risk Assessment, AML/CFT Policy, Customer Risk Profiling and Suspicious Transactions Reporting. Accordingly, the FIU-Sri Lanka conducted a detailed sector wise analysis based on the responses to the offsite thematic review questionnaires submitted by all DNFBPs.

**Table 3.2****The Number of Offsite Thematic Review Questionnaires Analysed by the FIU-Sri Lanka for the Second Quarter and Third Quarter**

Sector	Second Quarter	Third Quarter
Gem & Jewellery	35	37
Real Estate	31	36
Casino	3	03
Accountants & TCSPs	6	06
Lawyers & Notaries	3	04
<b>Total</b>	<b>78</b>	<b>86</b>

*Source: Financial Intelligence Unit-Sri Lanka*

However, there was a very low level of responses against the number of Institutions that are registered with FIU- Sri Lanka. Therefore, the FIU-Sri Lanka conducted a telephone survey on the Institutions that had not responded, which helped reveal that the low level of responses was due to temporary closures of such DNFBPs, lockdowns and travel restrictions stemming from the COVID-19 pandemic situation prevailing in the country.

#### b) Offsite Risk Assessment 2021

Despite the pandemic situation, the FIU-Sri Lanka carried out the annual offsite risk assessment for the DNFBPs sector to develop the on-site supervisory plan for the following year using the risk assessment tool developed by the IMF in 2018. In December 2021, the information related to inherent risk and risk mitigating measures were collected through a questionnaire that was circulated by the FIU- Sri Lanka.

Based on the responses to the offsite ML/TF questionnaires received at the end of 2021, the FIU-Sri Lanka conducted the offsite risk assessment for the purpose of identifying the risk level of DNFBPs and these Institutions were rated according to the total risk score on the basis given in table 3.3 below.

**Table 3.3**  
**Risk Categorization of DNFBPs Based on Offsite Risk Assessment**

Risk Score/ Percentage	Risk Categorization	DNFBP Sector				
		Casinos	Real Estate	Gem & Jewellery	Accountants and TCSPs	Lawyers and Notaries
Above 70%	High	-	02	02	01	01
Inclusive of 50% - 70%	Medium	-	54	48	05	05
Below 50%	Low	03	23	30	02	02
<b>Total</b>		<b>03</b>	<b>79</b>	<b>80</b>	<b>08</b>	<b>08</b>

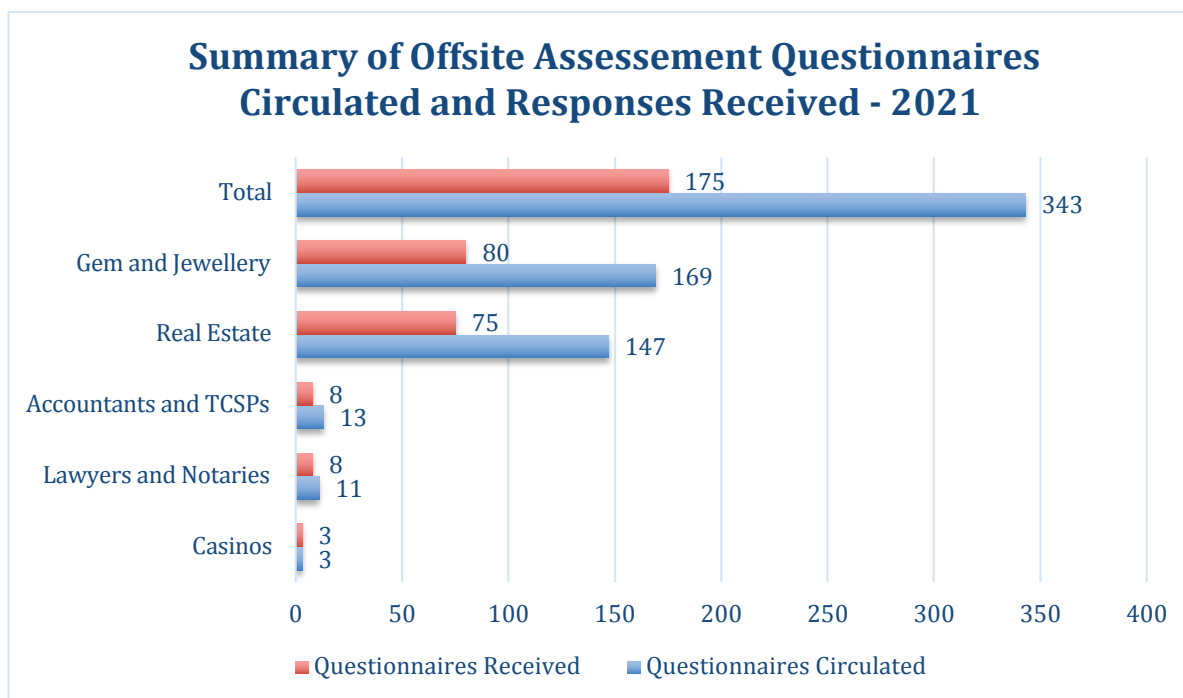
*Source: Financial Intelligence Unit-Sri Lanka*

Accordingly, 2 real estate agents, 2 gem and jewellery dealers, 1 TCSP, and 1 legal firm were rated as high-risk Institutions and most DNFBPs fell within the medium risk range as indicated above.

The onsite supervision plan for 2022 was prepared based on the risk levels depicted above and the FIU-Sri Lanka plans to conduct onsite supervision despite the challenges posed by the pandemic.

However, due to the low response rate of the DNFBPs, the FIU-Sri Lanka carried out follow-up activities such as sending reminder emails and contacting COs over the phone. Accordingly, the FIU-Sri Lanka was able to increase the number of responses received for the questionnaires. The number of questionnaires circulated and responses received are illustrated in Figure 3.1 below.

**Figure 3.1**



*Source: Financial Intelligence Unit-Sri Lanka*

### 3.2.3 Strengthening the AML/CFT Regime for DNFBPs

Despite the adverse impact of the COVID-19 pandemic in 2021, the FIU-Sri Lanka continued its efforts on steps to strengthen the AML/CFT regime for DNFBPs.

#### (a) Introducing a Regulatory Environment for the Real Estate Sector

The FIU-Sri Lanka submitted a comprehensive proposal to the Ministry of Finance for the establishment of a real estate regulatory authority, at the time of preparing the Government budget for 2022. Based on the proposal, a virtual meeting chaired by the Secretary of the Ministry of Finance where official stakeholders including officials from State Ministry of Rural Housing Constructions, Urban Development Authority, Condominium Development Authority, Construction Industry Development Authority and Registrar General's Department participated in, was conducted to discuss the sector's regulatory requirements

and explore the avenues available for introducing a regulatory body for the real estate sector. At the meeting, it was agreed in principle that a regulator was required for regulating identified activities of the real estate sector. The FIU-Sri Lanka proposed to enable the Construction Industry Development Act No. 33 of 2014 to provide for the Construction Industry Development Authority (CIDA) to function as the regulator.

Based on the meeting outcome, the FIU-Sri Lanka submitted a revised proposal on 'Formation of a Regulatory Environment for the Real Estate Sector', to the Ministry of Finance for further action. Currently, CIDA has submitted the proposal to National Advisory Council on Construction, and based on the instruction of the council, the proposal is to be submitted to the Board of Directors of CIDA for further approval.

### **(b) Market Awareness and Capacity Building for DNFBPs**

Despite the overwhelming challenges faced during the COVID-19 pandemic, the FIU-Sri Lanka continued its market awareness and capacity building programmes via online platforms. During the first half of 2021, the FIU-Sri Lanka held two workshops for Compliance Officers (CO) and top management personnel on 'Compliance with AML/CFT Obligations amidst the COVID-19 Pandemic' for the real estate sector in March 2021 and the gem and jewellery sector in April 2021.

Further, the FIU-Sri Lanka conducted another virtual awareness session in June 2021, with the collaboration of the Institute of Chartered Accountants of Sri Lanka (ICASL) on 'Accountants AML/CFT Obligations' with the purpose of providing accountants with a proper understanding of AML/CFT regulations in order to comply with the FTRA and Rules and Regulations issued thereunder. The FIU-Sri Lanka also delivered the keynote address at the virtual session on 'The Role of the FIU and Obligations of Directors and Board Secretaries' organized by the Sri Lanka Institute of Directors (SLID) in October 2021. In addition, the FIU-Sri Lanka hosted a virtual session on 'The Role of the FIU and TCSP's AML/CFT Obligations' with the collaboration of the Registrar of Companies (ROC) in November 2021.

In addition to the above awareness sessions, the FIU-Sri Lanka published newspaper notices, web notices and presentations from time to time, to educate the DNFBP sector institutions on the ongoing AML/CFT issues.

Further, the FIU-Sri Lanka increased the ways and means of outreach activities for the DNFBP sector by creating social media groups based on WhatsApp, social media and massaging platforms connecting all COs and Chief Executive Officers of registered DNFBPs to communicate in a convenient manner through an official mobile phone of the FIU-Sri Lanka. Accordingly, how the sector is misused for ML/TF and best practices to be followed within the sectors were shared along with many other important information among the DNFBPs.

### (c) Appointment of COs by DNFBPs

During the year 2021, the FIU-Sri Lanka continued onboarding new Institutions that operate in the capacity of a DNFBP thereby increasing the number of COs registered by such Institutions. New Institutions were identified through several sources such as newspaper advertisements, registrations with regulators and associations, lists received from the regional offices of CBSL, etc. Accordingly, the FIU-Sri Lanka officers contacted a significant number of entities during 2021 to identify new DNFBPs and to inform the requirement of appointing a CO. Further, subsequent to the telephone survey conducted by the FIU-Sri Lanka, Institutions that were identified to have closed down their business were removed from the list of DNFBPs.

The following table demonstrates the number of Institutions that have appointed COs as at December 31, 2021.

**Table 3.4**

**Number of COs Appointed by DNFBP Sectors as at 31.12.2021**

Sector	Number of Institutions that have appointed COs
Casino	3
Real Estate	152
Gem and Jewellery	169
Lawyers & Notaries	11
Trusts & Company Service Providers	5
Accountants	8
Total	<b>348</b>

*Source: Financial Intelligence Unit-Sri Lanka*

### (d) Coordination with Sector Regulators and Self-Regulatory Bodies

The officials of the FIU-Sri Lanka held continuous dialogue with the officials of the Condominium Management Authority (CMA), National Gem and Jewellery Authority (NGJA), Registrar of Companies (ROC), and ICASL to support the FIU-Sri Lanka in reaching out to the relevant DNFBP sectors, identifying new Institutions and introducing new AML/CFT measures.

Accordingly, the FIU-Sri Lanka had a virtual meeting with the Chairman of the NGJA in September 2021 to discuss matters related to the Gem and Jewellery sector and the way forward.



Further, officials of the FIU-Sri Lanka conducted a virtual meeting with the immediate past president of ICASL to develop an AML/CFT checklist for the use of audit firms.

### 3.2.4 Way Forward

Since 2017, the FIU-Sri Lanka has taken a number of steps to enhance the standard of the AML/CFT framework for DNFBPs in Sri Lanka, and it intends to pursue these efforts despite the continuing COVID-19 pandemic. Accordingly, while remaining within the new normalcy of the COVID-19 pandemic, the FIU-Sri Lanka intends to carry out onsite supervision according to the onsite supervision plan for 2022.

Further, sector specific virtual/ in person sessions for regulators, self-regulatory bodies and other related institutions have been planned to enhance awareness among the stakeholders on how to comply with the AML/CFT obligations.

Moreover, the FIU-Sri Lanka intends to enhance the outreach activities for the DNFBP sector on how the sector is exploited for ML/TF and the best practices to be followed within the sectors using brochures, other printed material with case studies and official mobile phone.

The FIU-Sri Lanka also intends to issue the 'Guidelines on AML/CFT Compliance Obligations for Lawyers, Notaries, Other Independent Legal Professionals and Trust and Company Service Providers' in 2022.

The FIU-Sri Lanka works in collaboration with many stakeholders to introduce and effectively implement AML/CFT measures for DNFBPs. To strengthen these interactions, the FIU-Sri Lanka intends to build a more collaborative environment to work with the Ministry of Finance, Bar Association of Sri Lanka, NGJA and CMA and other regulatory bodies associated with DNFBP sectors. Accordingly, the FIU-Sri Lanka expects to work in collaboration with the ICASL to identify the list of accountants who are providing captured activities as per Section 33 of the FTRA and to register them with the FIU-Sri Lanka. A similar process is expected to be adopted with ROC to identify a mechanism to identify the list of TCSPs who are providing captured activities as per Section 33 of the FTRA and to register them with the FIU-Sri Lanka.

In addition, the FIU-Sri Lanka hopes to continue its endeavors to establish a regulatory body for the real estate agents and supports the initiative to establish a regulatory body for the casino operators with the aim of strengthening a sound AML/CFT regulatory environment in Sri Lanka.

FIU-Sri Lanka continued to enhance capacity-building for its staff despite numerous challenges faced during the COVID-19 pandemic. The virtual nature of training programmes replaced the traditional classroom type training programmes. This approach provided more opportunities for the FIU-Sri Lanka to allocate more staff for training and development programmes due to the flexibility, cost-effectiveness and convenience of such programmes. Moreover, the introduction of novel platforms to conduct online programmes immensely contributed to achieving great success in non-face-to-face learning.

#### 4.1 Training Opportunities During 2021

During the year 2021, the FIU-Sri Lanka exercised maximum effort in continuing the capacity building of its staff by providing training opportunities on AML/CFT through webinars, web conferences and online training programmes. These programmes covered the areas of AML/CFT regulations and supervision for DNFBPs, counterterrorism and related cross-border investigations, virtual assets (VAs) and VASPs, information sharing between FIUs, LEAs and prosecutors, and creative journalistic writing skills.

In November 2021, FIU-Sri Lanka officers participated in a series of training organized by the APG on implementation of FATF Standards related to VAs and VASPs. Furthermore, the FIU-Sri Lanka officers participated in the Assessor Training Programmes which were conducted by the APG in May and November 2021.

Details of international and local training programmes/workshops/events attended by the officers of the FIU-Sri Lanka during the year 2021 are listed in Table 4.1 and Table 4.2, respectively.

**Table 4.1**

**International Training Programmes / Workshops / Events Attended by Officers of the FIU-Sri Lanka during 2021**

Month	Training Programme/Seminar/Workshop/Conference/ Meetings Attended	Institution
March	Online Programme on Anti-Money Laundering: The Italian Experience	Banca d' Italia
April	Webinar on DNFBP Regulation: FATF International Standards and Implementation	APG

May	Webinar on Obtaining Electronic Evidence from Private Service Providers in Counterterrorism and related Cross-Border Investigations	UNODC
	Webinar - APG Assessor Training	APG
June	Webinar on Risk Assessments and DNFBPs: Regulatory and Supervisory Strategies to Address Risks	APG
July	Webinar on Operational Training Session- Flexible, Consistent Information Exchange Standards – Moving to Production	Egmont Centre for FIU Excellence and Leadership (ECOFEL)
September	Webinar on VAs and VASPs	IMF – Singapore Regional Training Institute (STI)
	Webinar on Fight against Money Laundering and Financing Terrorism	Bank of France
	Webinar on Anti-Money Laundering	Banque de France
October	Webinar on Managing Digital Assets	Bureau of Educational and Cultural Affairs, USA
	Webinar on Anti-Money Laundering	Banque de France
	Webinar on Cooperation and Information Sharing between FIUs, LEAs and Prosecutors	ECOFEL
	Webinar on Risk-Based Supervision of DNFBPs	APG
November	APG Training Series on Implementation of FATF Standards relating to VAs and VASPs - Session 01	APG
	Webinar on Smuggling of Migrants	UNODC
	Online course “Financial stability”	Deutsche Bundesbank
	Webinar on Basic Principles of Trade Finance Processes and Trade - Suspicious Activity Reporting	ADB
	Webinar - APG Assessor Training (Online)	APG
December	APG Training Series on Implementation of FATF Standards relating to VAs and VASPs -Session 02	APG

Source: Financial Intelligence Unit-Sri Lanka

**Table 4.2:**  
**Local Training Programmes / Workshops / Events Attended by Officers of**  
**FIU-Sri Lanka during 2021**

Month	Training Programme /Seminar/ Workshop / Conference	Institution
January	Online sessions on Fund Management - Part I (Online)	CBS
June	Webinar on New Port City Act	Pathfinders
	Online Programme on Compliance for Non-Bank Financial Institution	CBS
July	Online Programme on Foreign Exchange Regulations for Financial Institutions	CBS
	Online Programme on Compliance for LCBs and LSBs	CBS
August	Webinar on Compliance with Income Tax	Inland Revenue Dept.
	Webinar on Income Tax Regulations and Submission of Income Tax Returns	Inland Revenue Dept.
October	Session on New Securities and Exchange Commission Act	Parthfinders
	Online Programme on Authentic Image Management, Personal Grooming, Social & Business Etiquette	CBS
	Webinar on Techniques of Effective Writing	CBS
November	Virtual Awareness Workshop on Creative Journalistic Writing Skills	CMD
	Webinar on Sri Lanka's Emergence as a Real Estate Investment Attraction	Ceylon Chamber of Commerce
	Online Programme on International Trade and Finance	CBS
December	Online Programme on MS Excel Advanced Course	CBS
	Online Programme on Introduction to Basic Econometrics using R Software	CBS

*Source: Financial Intelligence Unit-Sri Lanka*

## 4.2 Trending Developments in Capacity Building

Towards the end of year 2021, many countries across the globe initiated accepting the pandemic situation as the new normalcy. In keeping with this strategy, many institutions began to consider the potential for recommencing face-to-face learning, ensuring strict adherence to all health and safety rules. In this scenario, it is anticipated that face-to-face learning opportunities will be available together with non-face-to-face learning spaces during 2022. The FIU-Sri Lanka will also work towards implementing this strategy as this trend will facilitate maximizing the effectiveness of the learning aspects of its staff and thereby enhance its work effectiveness, which will ultimately contribute to building a robust AML/CFT framework in Sri Lanka.

Even amidst the adverse impact of the ongoing COVID-19 pandemic, the FIU-Sri Lanka managed to turn around the declining trend in coordinating awareness programmes faced during the previous year with a well-organized chain of awareness programmes in 2021. Accordingly, even though the COVID-19 pandemic created many limitations and challenges, the FIU-Sri Lanka successfully conducted 72 Awareness Programmes during the year, marking a significant increase in the number of programmes and participants compared to the previous year. Despite the limitations posed by the COVID-19 pandemic, the FIU-Sri Lanka conducted Awareness Programmes to enhance the effectiveness of the AML/CFT regime using modern technology to conduct distance training due to the restrictions imposed by health authorities for the benefit of the nation. Accordingly, the FIU-Sri Lanka used webinars, seminars, workshops, training programmes and meetings to enhance the understanding of the importance of AML/CFT measures and obligations in relation to AML/CFT. In addition, the FIU-Sri Lanka shared its knowledge of AML/CFT, providing resource persons as required. Further, the FIU-Sri Lanka used print and electronic media to publish press releases and paper notices to enhance compliance with AML/ CFT requirements and increase public awareness.

### **5.1 Seminars and Workshops Organized by the FIU-Sri Lanka**

The FIU-Sri Lanka conducted 65 awareness programmes island-wide, covering areas of CDD, compliance obligations, reporting requirements and identification of suspicious transactions, ML investigations, Law Enforcement Matters on ML/TF investigations, MVTS operations, UNSCR, Scams and Joint Supervision during 2021. Over 5000 participants representing RIs and LEAs participated in these programmes. Details of these programmes are given in Table 5.1.

**Table 5.1****Awareness Programmes Organized by the FIU-Sri Lanka in 2021**

<b>Date</b>	<b>Programme</b>	<b>Stakeholder</b>	<b>Venue/Mode</b>
13.01.2021	Requirements for January 1st half CTR reporting for goAML	All Banks	Virtual
20.01.2021	STR Reporting	Seylan Bank	FIU
21.01.2021	Commercial Banking Operations	CID	Virtual
22.01.2021	Commercial Banking Operations	CID	Virtual
22.01.2021	Requirements for January 1st half CTR reporting for goAML	DFCC Bank	Virtual
26.01.2021	ML Legal Framework	CID	Virtual
01.02.2021	Initiation of goAML Process for FIU's Call for Information Process	Pilot Banks	Virtual
05.02.2021	Demonstration of web reporting and mapping model	All Banks	Virtual
10.02.2021	Training for SIS and PNB on drug related crimes	NDDCB	Virtual
11.02.2021	UNSCR Awareness Session on FHA Monthly Forum	FHA	Virtual
15.02.2021	AML/CFT Compliance Programme for Financial Institutions	FIs	Virtual
16.02.2021	Training for SIS and PNB on drug related crimes	NDDCB	Virtual
16.02.2021	UNSCR Awareness Session	All RIs	Virtual
17.02.2021	STR Reporting	Peoples Bank	FIU
23.02.2021	Ez cash operations	CID	Virtual
25.02.2021	Awareness on STR Workbook	All FIs (Banks, Finance Companies and MVTs)	Virtual
05.03.2021	Awareness Session for Real Estate Agents on "Compliance with Anti-Money Laundering and Countering the Financing of Terrorism (AML/CFT) Obligations amidst the COVID-19 Pandemic"	Managing Directors/Chief Executive Officers and Compliance Officers of real estate institutions registered with the FIU	Virtual

<b>Date</b>	<b>Programme</b>	<b>Stakeholder</b>	<b>Venue/Mode</b>
16.03.2021	STR Reporting	Bank of Ceylon	CBSL
19.03.2021	STR Reporting	Commercial Bank	CBSL
19.03.2021	Introduction to Trade Finance Activities of Licensed Banks	CID	Virtual
23.03.2021	AML/CFT Compliance Programme for Financial Institutions	FIs	Virtual
23.03.2021	Awareness on Sanctioning, TF & NGOs	Compliance officers of LBs	CBSL
23.03.2021	AML/CFT Compliance Programme for Financial Institutions	FIs	Virtual
26.03.2021	UNSCR Awareness Session	All RIs	Virtual
28.03.2021	Legislations Relating to Banking and Financial Institutions	Participants from RIs	Virtual
01.04.2021	Awareness Session for Gem and Jewellery Dealers on "Compliance with Anti-Money Laundering and Countering the Financing of Terrorism (AML/CFT) Obligations amidst the COVID-19 Pandemic	Managing Directors/Chief Executive Officers and Compliance Officers of gem and jewellery institutions registered with the FIU	Virtual
27.04.2021	Stakeholder-wise Action Plan to Improve the Effectiveness of AML/CFT Regime in Sri Lanka	Staff from SNBFI, BSD, IRCSL and SEC	Virtual
29.04.2021	Awareness on Scams	University of Moratuwa	Virtual
10.05.2021	AML/CFT Compliance Programme for Financial Institutions	FIs	Virtual
11.05.2021	Training on AML/CFT Compliance	Officers from FIs	Virtual
13.05.2021	UNSCR Awareness Session	All RIs	Virtual
10.06.2021	Training on FIU Operations	Officers from other regulatory Departments (BSD, DFE, PSD, SNBFI)	Virtual

<b>Date</b>	<b>Programme</b>	<b>Stakeholder</b>	<b>Venue/Mode</b>
25.06.2021	Awareness on AML/CFT Compliance	Officers from Police and FIs	Virtual
30.06.2021	Session on AML/CFT Obligations of Accountants, Auditors and Trust and Company Service Providers	ICASL members	Virtual
02.07.2021	STR Reporting	HNB	Virtual
02.08.2021	Issues of Banks on CDD measures	Officers of Deutsche Bank	Virtual
04.08.2021	STR Reporting	Mobitel	Virtual
13.08.2021	Training on Best Practices for Bank Tellers	Officers from FI	Virtual
01.09.2021	Program for Chief Inspectors of Police	Police	Virtual
03.09.2021	Program for Chief Inspectors of Police	Police	Virtual
07.09.2021	Training on AML/CFT Compliance	Officers from FIs	Virtual
08.09.2021	Regulatory Framework Relating to Non-Bank Financial Institutions	RFCs	Virtual
08.09.2021	Stakeholder-wise Action Plan to Improve the Effectiveness of AML/CFT Regime in Sri Lanka	Staff from SNBFI and FIU	Virtual
09.09.2021	Online Programme on AML/CFT Compliance for Financial Institutions	Participants from RIs	Virtual
09.09.2021	Programme on AML/CFT Compliance for Financial Institutions	Participants from RIs	Virtual
09.09.2021	UNSCR Awareness Session	All RIs	Virtual
23.09.2021	Program for Chief Inspector of Police	Police	Virtual
28.09.2021	Awareness on Anti Money Laundering and Countering the Financing of Terrorism	Government officials, Bank Officers and General public	Virtual
28.09.2021	Legislations relating to banking and financial institutions	Officers from FI & CBSL	Virtual



<b>Date</b>	<b>Programme</b>	<b>Stakeholder</b>	<b>Venue/Mode</b>
30.09.2021	Program for Chief Inspectors of Police	Police	Virtual
08.10.2021	Awareness on Scams	University of Moratuwa	Virtual
13.10.2021	STR Reporting	TRCSL	Virtual
23.10.2021	Programme for Chief Inspectors of Police	Police	Virtual
26.10.2021	Stakeholder-wise Action Plan to Improve the Effectiveness of AML/CFT Regime in Sri Lanka	FIU, SEC	Virtual
27.10.2021	Programme for Chief Inspectors of Police	Police	Virtual
02.11.2021	Awareness through CMD for CBSL YouTube Channel	Public awareness	Virtual
11.11.2021	Awareness on ML/TF & FIU Operations	CID	CBSL
27.11.2021	Programme for Chief Inspectors of Police	Police	Virtual
03.11.2021	Stakeholder-wise Action Plan to Improve the Effectiveness of AML/CFT Regime in Sri Lanka	FIU, IRCSL	Virtual
02.12.2021	AML/CFT Compliance Programme	All Banks (Corporate Management)	Virtual
02.12.2021	High-Level Web Conference on "Creating a Culture of AML/CFT Compliance" for Board of Directors and Key Management Personnel of the Licensed Banks	BODs, KMPs of FI (Banks, LFCs)	Virtual
06.12.2021	Training on AML/CFT Compliance	Officers from FI	Virtual
07.12.2021	Training on AML/CFT Compliance	Officers from FI	Virtual
09.12.2021	UNSCR Awareness Session	All RIs	Virtual
29.12.2021	Awareness on Money laundering and Terrorist Financing	Officers of LBs & LFCs in Northern Province	Virtual

*Source: Financial Intelligence Unit-Sri Lanka*

## 5.2 Depth and Breadth of Awareness Programmes Conducted During 2016-2021

The FIU-Sri Lanka gradually increased the number of Awareness Programmes conducted and the number of participants during the 5-year period from 2016 to 2021. During the year 2020 the FIU-Sri Lanka faced some difficulties to conduct awareness programmes as planned due to the unexpected COVID-19 pandemic. However, in comparison to 2020, the FIU-Sri Lanka achieved significant progress in Awareness Programmes conducted as well as the number of participants despite the pandemic situation that prevailed in 2021.

**Table 5.2**

### Depth and Breadth of Awareness Programmes Conducted by the FIU-Sri Lanka During 2016-2021

Year	Number of Awareness Programmes	Number of Participants	Districts Covered
2016	30	1,630	Colombo, Matara, Matale, Kurunegala, Galle, Jaffna
2017	35	2,624	Colombo, Batticaloa, Trincomalee, Matara, Anuradhapura, Nuwara Eliya
2018	61	3,412	Colombo, Trincomalee, Matale, Anuradhapura, Matara
2019	55	3,688	Anuradhapura, Batticaloa, Colombo, Jaffna, Killinochchi
2020	27	1,978	Colombo, Galle, Matara and island-wide coverage with online programmes
2021	65	Over 5,000	Island-wide coverage with online programmes

## 5.3 Awareness through Print and Electronic Media

Since the FIU-Sri Lanka considered advertising as an effective and convenient means of increasing awareness among a larger proportion of the public, the FIU-Sri Lanka published advertisements regarding risks of getting involved in informal money transfer schemes, in order to encourage the use of formal channels. These advertisements were published through print and electronic media in Sinhala, Tamil and English languages.

**Table 5.3**  
**Advertisements Published During 2021**

Date	Press Release/ Notice
10.12.2021	Public awareness on risks in getting involved in informal money transfer schemes - Notice 1 (in Sinhala, Tamil and English languages)
10.12.2021	Public awareness on risks in getting involved in informal money transfer schemes - Notice 2 (in Sinhala, Tamil and English languages)
10.12.2021	Public awareness on risks in getting involved in informal money transfer schemes - Notice 3 (in Sinhala, Tamil and English languages)

## 6.1 Introduction

For any FIU, receipt of transactions data from RIs is a challenging task due to the complex nature and high volume of transactions. As the complexity of operations and number of transactions increase, receipt of reports from RIs requires IT infrastructure that can receive, validate and process the transaction data in those reports. Many FIUs have utilized the internet for receipt of transaction reports from RIs online and used the eXtensible Markup Language (XML) to structure the reports. Usage of XML for transaction reports enables the automated validation and processing of large volumes of transactions data in the reports. The FIU-Sri Lanka receives on average 6.8 million transactions (for all forms of transactions) from RIs for a year. Therefore, usage of IT infrastructure for reporting is an essential part of the FIU-Sri Lanka's operations.

Section 6 of the FTRA and the Extraordinary Gazette No. 1555/9 dated 25 June 2008, require all Institutions (as defined in the FTRA) to report to the FIU-Sri Lanka, any cash transaction or an electronic funds transfer of a customer, exceeding LKR 1 million or its equivalent in any foreign currency, in such form, manner and within such period prescribed by the FIU-Sri Lanka. Accordingly, RIs commenced reporting of CTRs, EFTs and STRs to the FIU-Sri Lanka on 15 September 2006. At the initial stage, the reporting was done manually via hard copies and computer diskettes.

Since the introduction of the 'LankaFIN' web-based reporting system (developed by CBSL's Information Technology Department on 01 July 2009), RIs have been submitting the threshold reports (CTRs and EFTs) and STRs to the FIU-Sri Lanka online through the LankaFIN system. At the end of 2021, there were 24 LCBs, 6 LSBs, 39 LFCs, 28 ICs, 29 SBs, and 3 MVTS providers reporting to the LankaFIN system. The FIU-Sri Lanka is also in the process of including other business categories under the reporting purview (such as Margin Traders and Primary Dealers), considering their significance in the AML/CFT process.

## 6.2 LankaFIN Online Reporting System

The LankaFIN online system was developed for the following main functions:

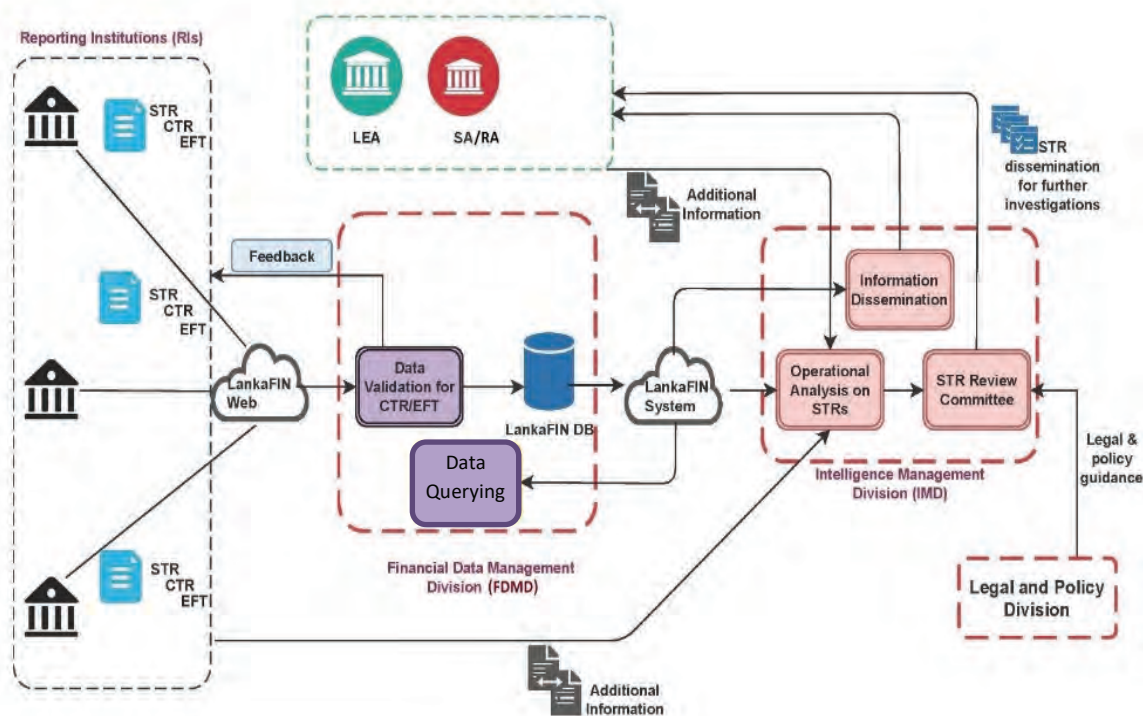
- (a) Receipt of mandatory threshold reports (CTRs and EFTs) from RIs
- (b) Receipt of STRs from RIs

- (c) STR case management
- (d) Statistical reporting
- (e) Querying/Searching customer details (from threshold reports)
- (f) Management of information of Compliance Officers (COs) and RIs.

Figure 7.1 illustrates information receipt from RIs, analysis and dissemination mechanism within the FIU-Sri Lanka, and the role of the LankaFIN system in this mechanism.

**Figure 6.1**

**Reporting, Analysis and Dissemination of Information in the FIU-Sri Lanka**



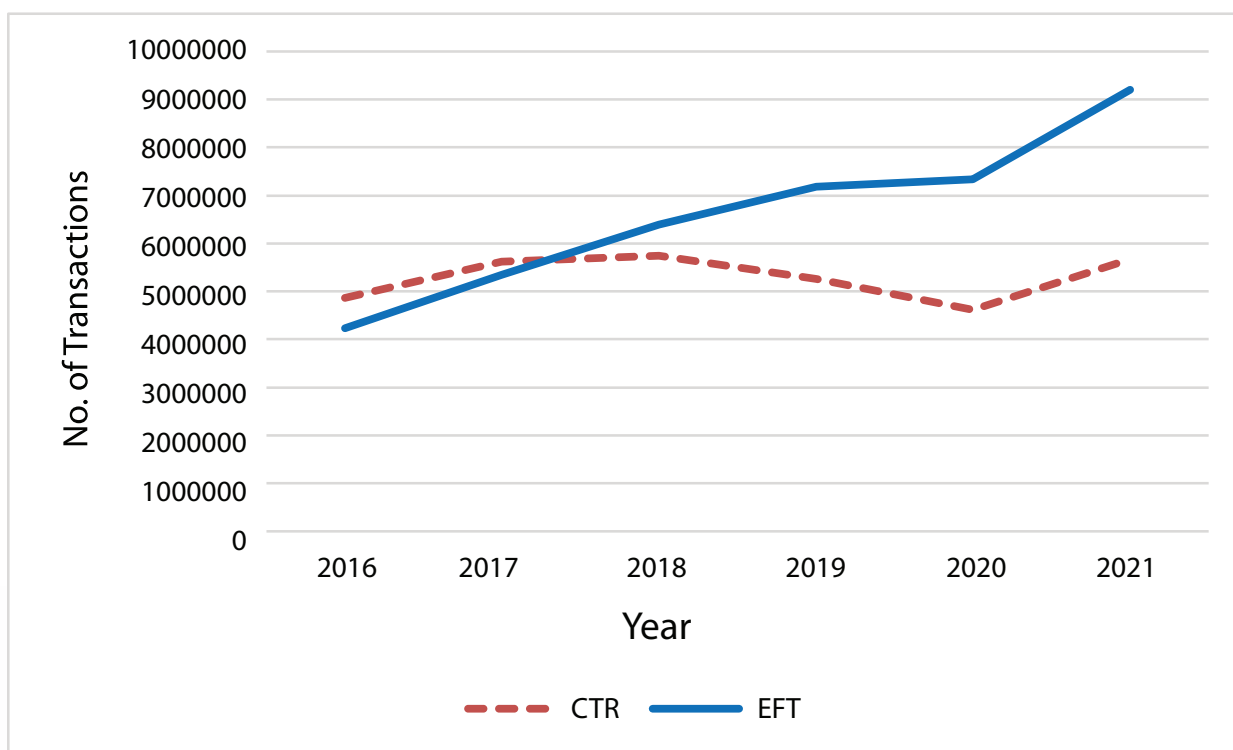
*Source: Financial Intelligence Unit-Sri Lanka*

The web-based data transfer file type XML is used in the LankaFIN reporting system. LCBs, LSBs and LFCs are required to submit CTR and EFT reports fortnightly, while ICs, SBs and MVTS providers are required to report them monthly.

In 2020, the FIU-Sri Lanka introduced a software tool for RIs to validate the threshold reports before submitting to the LankaFIN system. This improved the accuracy and completeness of transaction data submitted by RIs to the FIU-Sri Lanka, and reduced the resources and effort required to validate the reports from the FIU-Sri Lanka's side as well. During 2021, the FIU-Sri Lanka continued to provide assistance to RIs on the usage of the validation tool (mainly as guidance and updates to the tool).

The data submitted by RIs as threshold reports are uploaded to the LankaFIN database, which is the FIU-Sri Lanka’s data repository for analysis purposes. During 2021, the LankaFIN database received more than 5.6 million Cash Transaction (CT) records and 9.2 million Electronic Fund Transfer (EFT) records from RIs. Figure 7.2 illustrates the total number of CT and EFT records received to the LankaFIN database during the 5-year period of 2016–2021.

**Figure 6.2**  
**Total Number of CT and EFT Records Received through the LankaFIN System During 2016-2021**



**Table 6.1: Receipt of CT & EFT Records through LankaFIN System**

Year	2016	2017	2018	2019	2020	2021
No. of CTRs	4,860,796	5,627,396	5,743,308	5,257,620	4,616,292	5,665,021
No. of EFTs	4,232,279	5,346,084	6,386,376	7,176,739	7,339,385	9,201,994
<b>Total</b>	<b>9,093,075</b>	<b>10,973,480</b>	<b>12,129,684</b>	<b>12,434,359</b>	<b>11,955,677</b>	<b>14,867,015</b>

Source: LankaFIN, Financial Intelligence Unit-Sri Lanka

### 6.2.1 Submission of STRs through LankaFIN

As per Section 7 of the FTRA, every Institution should report any suspicious transaction or attempted transaction to the FIU-Sri Lanka within 2 working days, regardless of the amount of the transaction. RIs can submit STRs to the FIU-Sri Lanka through the LankaFIN system at any time. Additional information relevant to the submitted STRs were obtained from RIs through email or fax, as and when necessary.

### 6.2.2 Analysis Using LankaFIN

RIs submit two types of data to the FIU-Sri Lanka in the threshold reports and STRs. They are (i) data on the customers (CDD data) and (ii) data on the transactions (transaction data). During 2021, the FIU-Sri Lanka continued to conduct further analysis on the individuals, accounts and entities mentioned in the STRs received. The data available in the FIU-Sri Lanka's database (LankaFIN database) is used in this analysis to reveal other individuals, entities and accounts associated with the primary suspected cases of STRs (operational analysis). Often, information available to the FIU-Sri Lanka from other sources (including RIs) were used in operational analysis.

The FIU-Sri Lanka also continued to focus on the descriptive products of the strategic analysis in 2021, which was useful in planning and performance management of the FIU-Sri Lanka's activities and resource allocation. With qualitatively and quantitatively enhanced data, strategic analysis enables a wider range of more useful products such as indicators, typologies, trends, and other intelligence products (forward looking and predictive formal assessments aimed at answering specific questions). The FIU-Sri Lanka procured a new AML/CFT reporting and analysis system named 'goAML' in 2018 to enhance the analysis functions of its operations. As the effectiveness of any type of analysis, i.e., operational and strategic, is highly dependent on the quality and validity of data reported by RIs, the FIU-Sri Lanka continued to put more effort on receiving complete and accurate data from RIs throughout the year 2021.

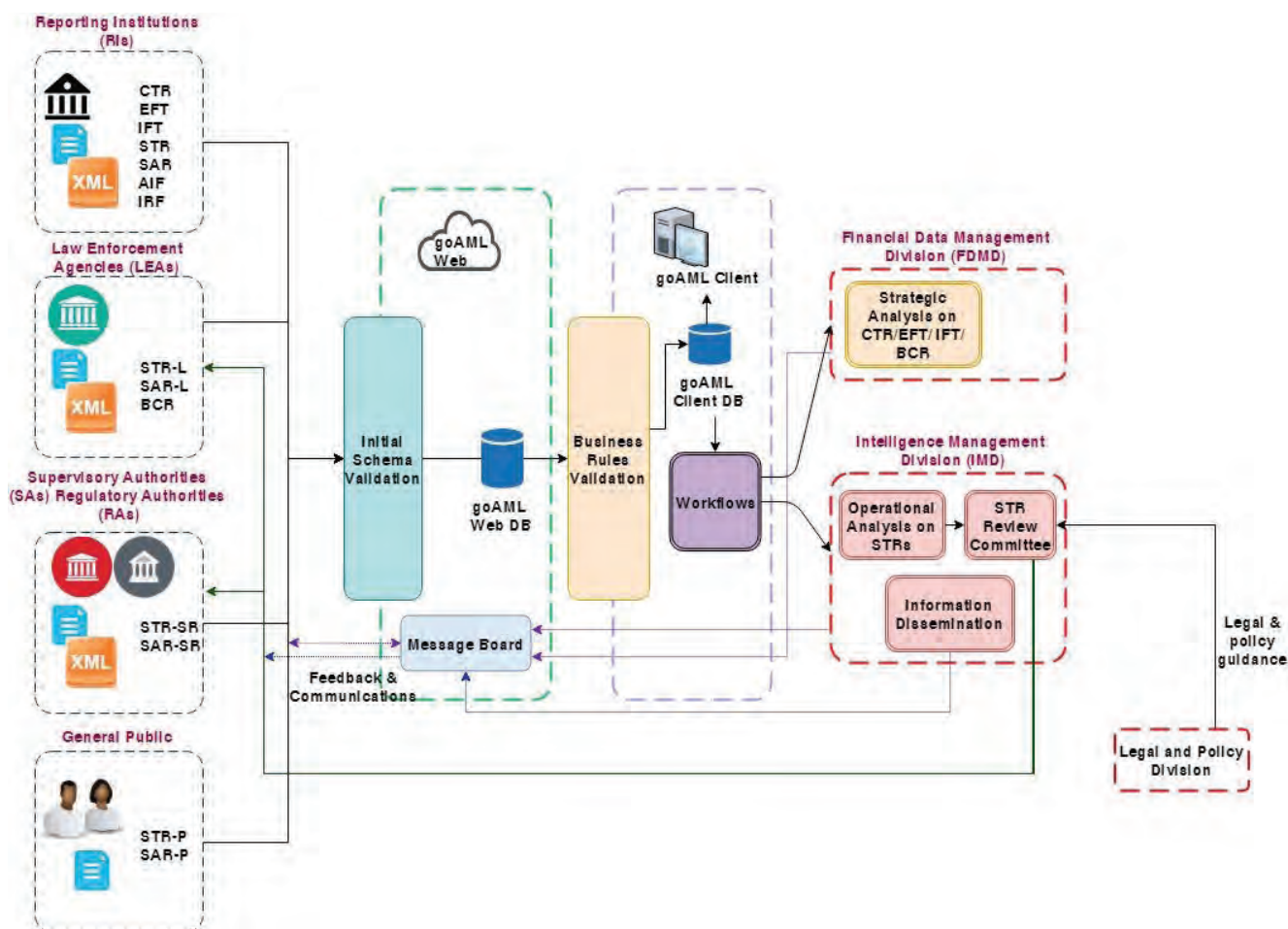
## 6.3 The goAML Software System

### 6.3.1 Introduction

The 'goAML' is an AML/CFT online reporting and analysing system developed by the UNODC specifically for FIUs, as a strategic response to ML/TF financial crimes. The goAML is essentially an integrated database and intelligent analysis system with a desktop application for the FIU and a web interface for RIs. Its comprehensive report structure, i.e., XML Schema, enables collecting more and structured details from RIs about transactions, making the data more analysis-friendly than the LankaFIN system. However, it has been a challenge for both the FIU-Sri Lanka and RIs to accurately implement the goAML system, because of the comprehensive structure.

Figure 6.3:

### Functionality of the goAML Software System



Source: Financial Intelligence Unit-Sri Lanka

#### 6.3.2 Implementing the goAML System

During 2021, the FIU-Sri Lanka focused more on the implementation of goAML system from the RI's side (mainly LCBs and LSBs). For this part of the implementation, LCBs and LSBs were required to develop systems to generate XML reports for submitting threshold reports to the goAML system. The FIU-Sri Lanka provided assistance and guidance to LCBs and LSBs through the following actions:

- Conducting online meetings and awareness sessions for LCBs and LSBs to discuss and provide solutions for the issues encountered during system developments.
- Providing documentation on the various aspects of the goAML system such as schema updates, business rules and a web user manual.
- Initiating an Information Systems Audit (IS Audit) by LCBs and LSBs to assess the gaps between FIU requirements and generated reports.



Despite the restricted working conditions due to the COVID-19 pandemic, the FIU-Sri Lanka and licensed banks were able to commence live operations of goAML for the FIU-Sri Lanka's 'Call For Information (CFI)' process on 01 August 2021. Further, work related to commencing live operations for (i) STR reporting process by LCBs and LSBs and Finance Companies and (ii) threshold reporting by licensed banks was also completed during 2021. Accordingly, live reporting for both above processes in goAML commenced in February 2022.

## 6.4 The FIU-Sri Lanka Website

The official website of the FIU-Sri Lanka was launched on January 01, 2014 and since then it has become a primary source of information for both the domestic and international stakeholders on the FIU-Sri Lanka's operations and related activities.

Visit: <http://fiusrilanka.gov.lk>

The website broadly provides information on recent events, new pieces of legislation and amendments, circulars, publications, notices, and updates on the UNSCRs, etc.

A list of documents made available on the website during the year 2021 is given below:

- ◆ Circular 04/2021 – Deposits made under the Finance Act, No. 18 of 2021
- ◆ Guidelines for Financial Institutions on CCTV Operations for AML/CFT Purposes, No. 2 of 2021
- ◆ Circular 03/2021 – Additional measures to mitigate the emerging Money Laundering/ Terrorist Financing risks during the third wave of the COVID-19 Pandemic
- ◆ Circular 02/2021 – Trends in Foreign Currency Outflows via ATMs: Cash withdrawals in Overseas
- ◆ Circular 01/2021 – Implementation of AML/CFT measures on parties involved with online payment platforms
- ◆ Press releases/notices by FIU-Sri Lanka on the following:
  - i. Public awareness on risks in getting involved in informal money transfer schemes - December 10, 2021
  - ii. Imposition of Administrative Penalties by the FIU-Sri Lanka to Enforce Compliance on Financial Institutions during the Third Quarter of 2021 - November 2, 2021
  - iii. Imposition of Administrative Penalties by the FIU-Sri Lanka to Enforce Compliance on Financial Institutions during the Second Quarter of 2021 - July 20, 2021

- iv. Imposition of penalties to enforce compliance on Financial Institutions during the first quarter of 2021 by the FIU-Sri Lanka - May 19, 2021
- v. Public awareness on Risks in investing in Virtual Currencies in Sri Lanka by the Central Bank of Sri Lanka - April 09, 2021
- vi. Imposition of penalties to enforce compliance on Financial Institutions during 2020 by the FIU-Sri Lanka - January 11, 2021
- ◆ Update notifications for the UNSCR lists pursuant to
  - i. UNSCR 1267, 1988, 1989, 2253 and subsequent resolutions on Al-Qaeda, ISIL and Taliban terrorists
  - ii. UNSCR 1373 on local terrorists (February 25, 2021)
- ◆ 2020 Annual Report of FIU-Sri Lanka

## **6.5 Assistance Provided for Law Enforcement Agencies (LEAs) on Information Management and Sharing**

In 2021, the FIU-Sri Lanka initiated two projects to develop Data Management Systems (DMSs) for the Attorney General's Department (AGD) and the Sri Lanka Police, for the management of their data relating to investigations and prosecutions. The proposed model of the DMS for the Sri Lanka Police was presented to the Inspector General of Police on June 03, 2021, and the completed DMS for AGD was handed over to the Hon. Attorney General on November 11, 2021. Through the development of these DMSs, the FIU-Sri Lanka expects to enhance the online information sharing mechanism with stakeholders such as the AGD and Sri Lanka Police.

## **6.6 Future Challenges**

The challenges arising from the COVID-19 pandemic in 2020 continued to prevail in 2021 as well, making 2021 as well a challenging year for the FIU-Sri Lanka. As the LCBs and LSBs were struggling to continue system developments for goAML reporting with restricted working conditions and limited resources, the FIU-Sri Lanka had to revise the commencement of goAML live operations several times during the year. Throughout the year 2021, the FIU-Sri Lanka continued to provide support for the LCBs and LSBs for their system developments by providing technical clarifications and guidance for the various issues faced by the LCBs and LSBs. The FIU-Sri Lanka's biggest challenge will be bringing the level of goAML reporting of RIs to the expected level of high accuracy and completeness.

## CONTACT US

For enquiries about FIU-Sri Lanka or other related information, contact details are given below.

### **General**

Telephone: +94 11 247 7509

Fax: +94 11 247 7692

Email: [fiu@cbsl.lk](mailto:fiu@cbsl.lk)

Website: <http://fiusrilanka.gov.lk>

### **Director FIU**

Mrs. E H Mohotty

Director

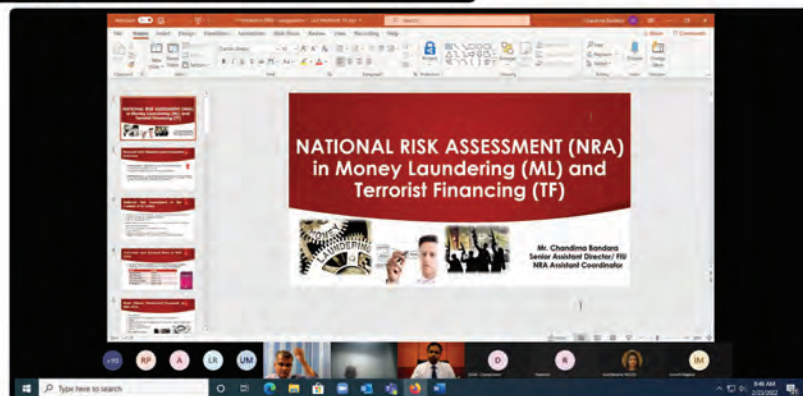
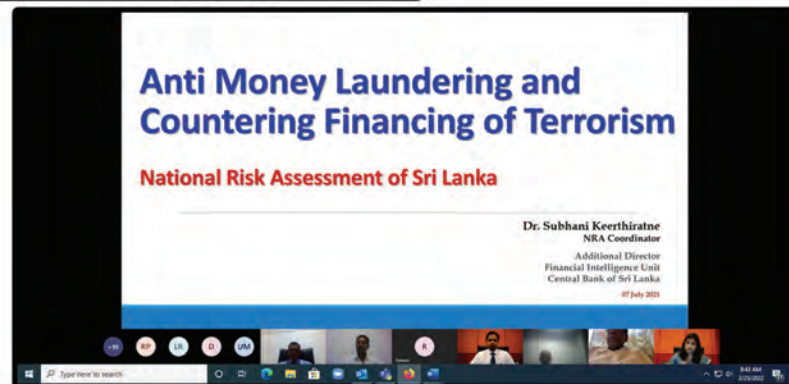
Financial Intelligence Unit of Sri Lanka

Central Bank of Sri Lanka, No: 30, Janadhipathi Mawatha, Colombo 01,  
Sri Lanka

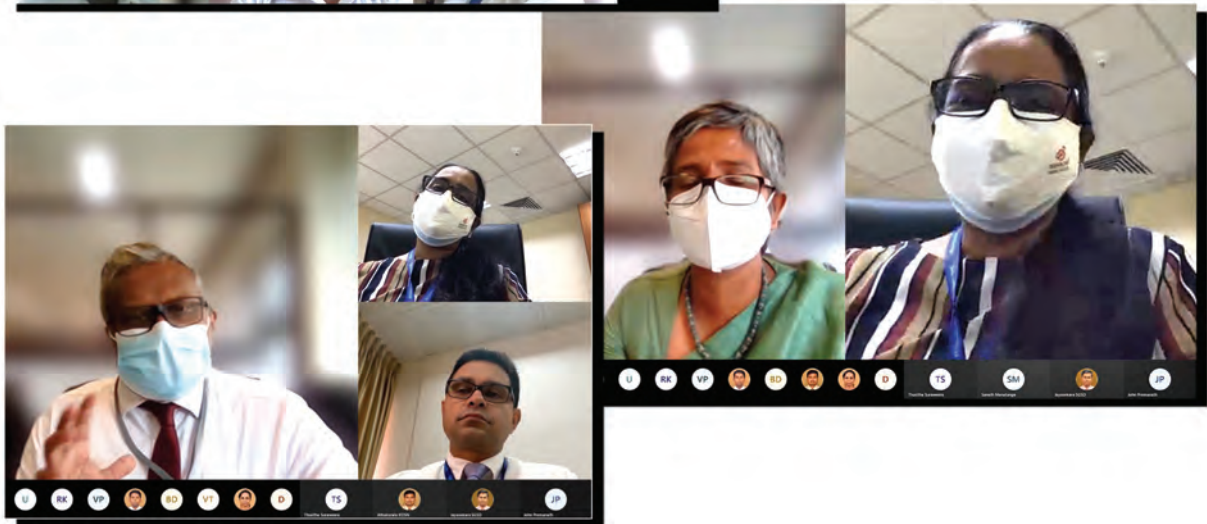
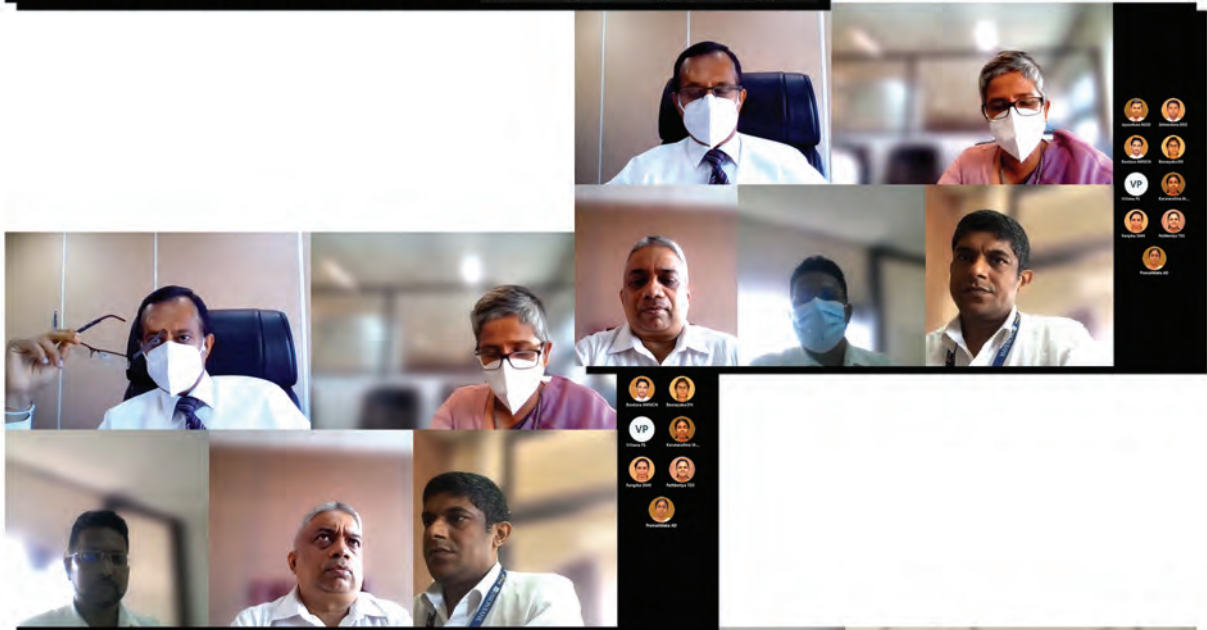
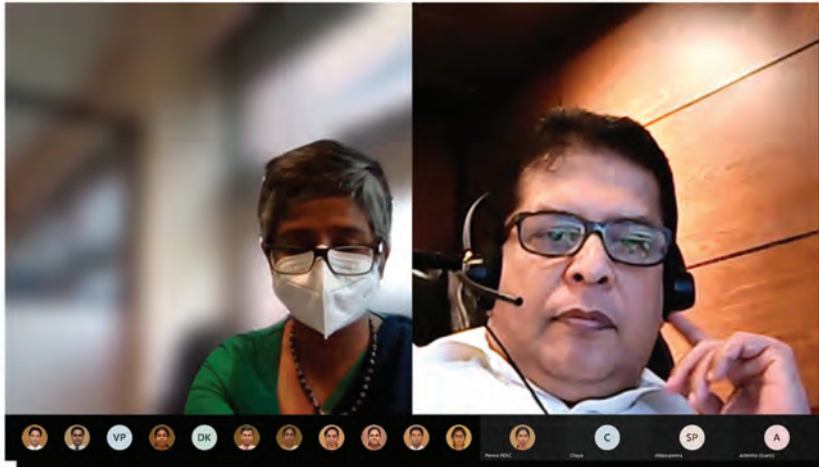
Email: [director@fiusrilanka.gov.lk](mailto:director@fiusrilanka.gov.lk)

Telephone: +94 11 247 7125

## National Risk Assessment of Sri Lanka 2021/22



# Follow up Meetings



# Highlevel Seminar on Creating a Culture of AMLCFT

**“Creating a Culture of AML / CFT Compliance”**  
**High-Level web conference for BOD and KMP of LBs and LFCs**

**LIVE WEBINAR**  
**2 DECEMBER**  
 @ 2.00 p.m. to 4.00 p.m.

Opening Remarks by  
 Mrs D R Karunaratne  
 Director  
 Financial Intelligence Unit

Resource Persons  
 Mr A M Thassim  
 Assistant Governor  
 Central Bank of Sri Lanka  
 Dr (Mrs) Subhani Keerthiratne  
 Addl. Sonal Director  
 Financial Intelligence Unit

For more information contact:  
 Ms Sajini Chandrasekara  
 Assistant Director, Financial Intelligence Unit  
 saj@cbdl.lk | 0112 477 163

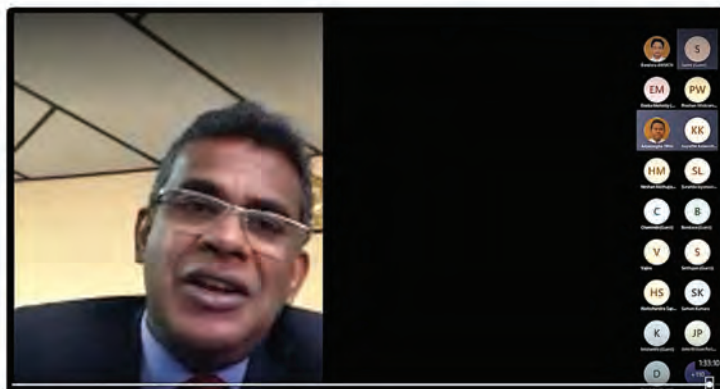
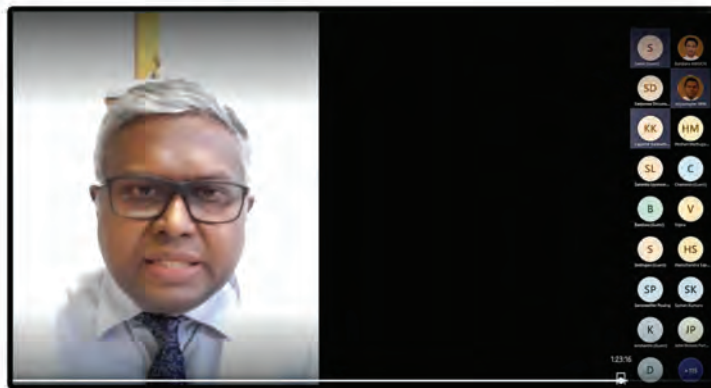
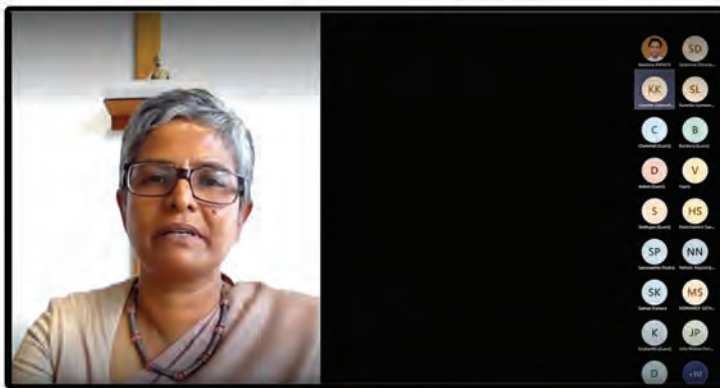
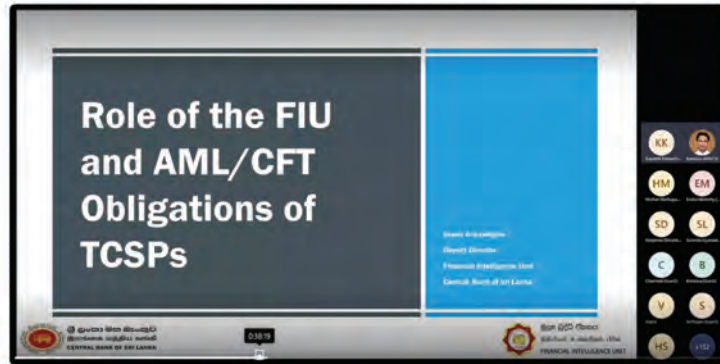
10 participants from each institution

සම මගින් සහභාගී වන්න  
 FINANCIAL INTELLIGENCE UNIT

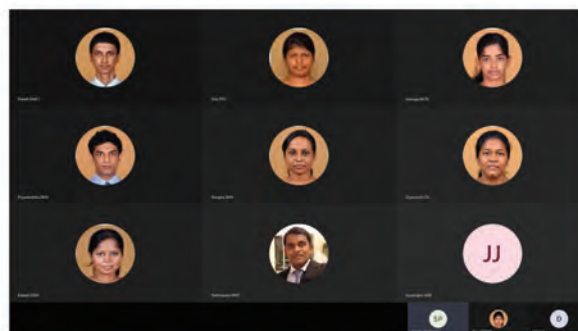
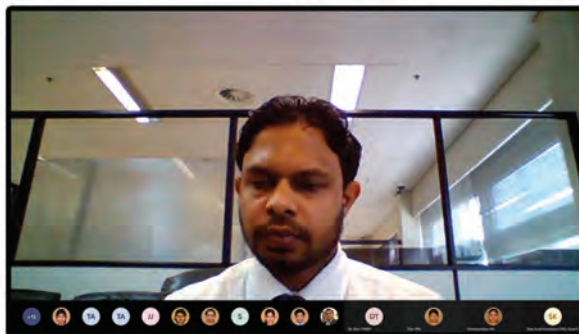
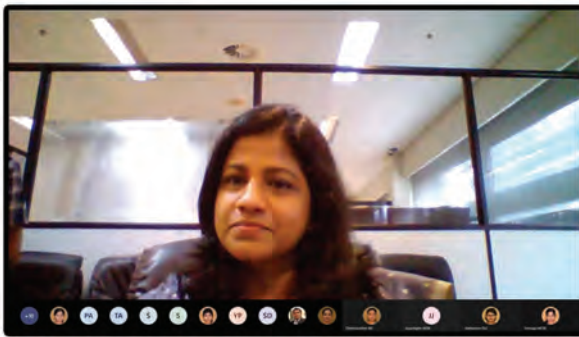
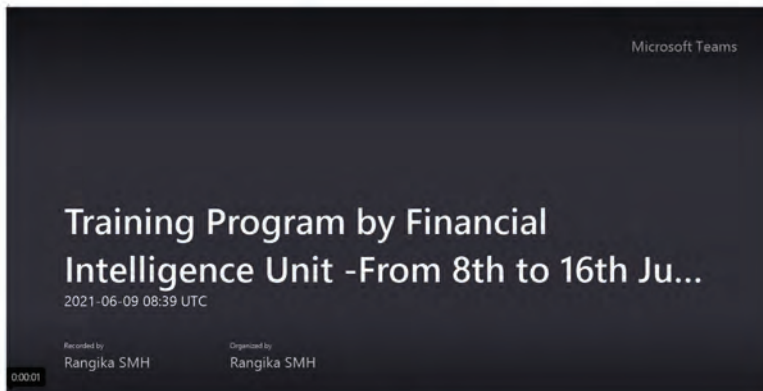
සම මගින් සහභාගී වන්න  
 CENTRAL BANK OF SRI LANKA



**Online Webinar on Role of the FIU and AML/CFT Obligations of Trust or Company Service Providers organized by the FIU with collaboration of Registrar of Companies**

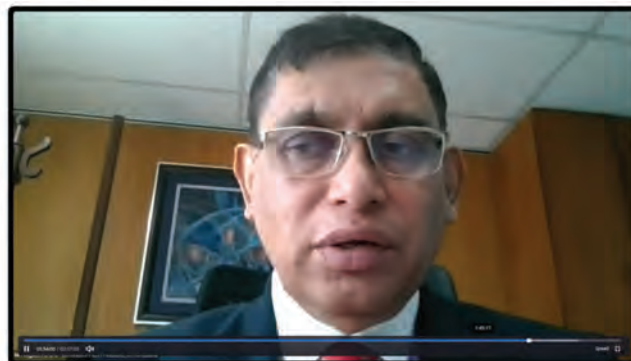
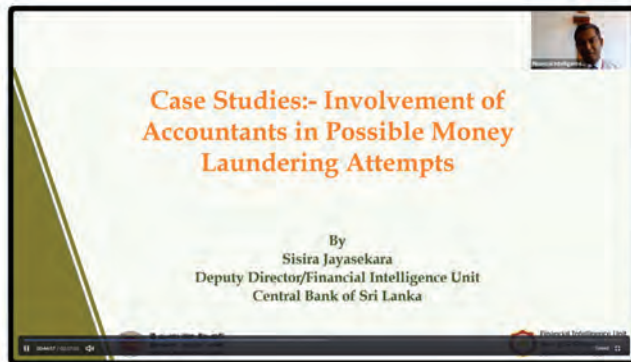


# Training organized by FIU to Regulatory Departments





# Online webinar on AML/CFT Obligations of Accountants, Auditors & Trust and Company Service providers organized by Institute of Chartered Accountants of Sri Lanka



**Virtual Session on ANTI-MONEY LAUNDERING AND COUNTERING FINANCING OF TERRORISM**  
Obligations of Accountants, Auditors and Trust & Company Service Providers

Session outline	Presenter
Role of the Financial Intelligence Unit (FIU) and international requirements concerning accountants	<b>Mr. Aiyesh Ariyasinghe</b> Deputy Director Financial Intelligence Unit, Central Bank of Sri Lanka
Case Studies ; Money Laundering Schemes supported by Accountants	<b>Mr. Sisira Jayasekara</b> Deputy Director Financial Intelligence Unit, Central Bank of Sri Lanka

**PANELISTS**

- Mrs. Enoka Mohotty**  
Director  
Financial Intelligence Unit,  
Central Bank of Sri Lanka
- Mr. Chandima Bandara**  
Senior Assistant Director –  
Financial Intelligence Unit,  
Central Bank of Sri Lanka
- Miss. Malsha Rathnayake**  
Assistant Director  
Financial Intelligence Unit,  
Central Bank of Sri Lanka
- Mr. Lasantha Wickremesinghe**  
Past President,  
CA Sri Lanka

**MODERATOR**

- Mr. Jagath Perera**  
Immediate Past President,  
CA Sri Lanka

**CPD**

<b>Date</b> 30th June 2021	<b>Time</b> 2.00 pm – 4.00 pm (Presentation followed by a Panel Discussion)	<b>Mode of Delivery</b> Zoom	<b>Investment</b> Free
-------------------------------	--	---------------------------------	---------------------------

**Target Group: CA Sri Lanka Members**

For Registrations:  
Fatima on 011-2552024  
Email: fatima.rehman@casrilanka.org  
The Institute of Chartered Accountants of Sri Lanka  
30A, Malalasekera Mawatha, Colombo 7,  
www.casrilanka.com

Registrations on a first come first served basis  
[CLICK HERE TO REGISTER ONLINE](#)



### 2021

1. Implementation of AML/CFT measures on parties involved with online payment platforms, Circular 01/2021
2. Trends in Foreign Currency Outflows via ATMs: Cash withdrawals overseas, Circular 02/2021
3. Additional measures to mitigate the emerging Money Laundering/ Terrorist Financing risks during the third wave of the COVID-19 Pandemic, Circular 03/2021
4. Guidelines for Financial Institutions on Enhancing STR Reporting Quality No. 1 of 2021
5. Guidelines for Financial Institutions on CCTV Operations for AML/CFT Purposes, No. 2 of 2021
6. Guidelines for Financial Institutions on Suspension of Transactions under Section 15 (2) of the FTRA, No. 3 of 2021
7. Deposits made under the Finance Act, No. 18 of 2021, Circular 04/2021

### 2020

1. Guidelines for LFCs, ICs and SBs on Scenario-based LankaFIN Reporting, No. 1 of 2020
2. Extraordinary Measures of Extending the Deadline for Submission of Threshold Reports, Circular No. 01/20
3. Extraordinary Measures of Extending the Deadline for Submission of Threshold Reports: Second Extension, Circular No. 02/20
4. Guideline for Accountants and Trust or Company Service Providers on Anti-Money Laundering and Countering the Financing of Terrorism Compliance Obligations, No. 2 of 2020
5. Advice to Financial Institutions to Be Vigilant on the Emerging Money Laundering/ Terrorist Financing Risks, Circular No. 03/20
6. Direction on Contacting Compliance Officials during Weekends/Public and Bank Holidays, No. 1 of 2020
7. Guidelines on Non-Face-to-Face Customer Identification and Verification Using Electronic Interface Provided by the Department for Registration of Persons, No. 3 of 2020

## 2019

1. Insurers (Customer Due Diligence) Rules, No. 1 of 2019 - Extraordinary Gazette No. 2123/14, May 13 of 2019
2. Conducting Enhance Due Diligence with Respect of the Non-Governmental Organizations, Not-for-Profit Organizations or Charities under Financial Institutions (Customer Due Diligence) Rules, No. 1 of 2016, Circular No. 01/19
3. Guidelines for Designated Non-Finance Businesses on Suspicious Transactions Reporting, No. 01 of 2019
4. Guidelines for Designated Non-Finance Businesses on Identification of Beneficial Ownership, No. 02 of 2019
5. Guidelines on Identification of Politically Exposed Persons, No. 03 of 2019
6. Debiting Withholding Taxes from Suspended Accounts, Circular No. 02/19

## 2018

1. Rules for Designated Non-Finance Business (Customer Due Diligence) Rules, No. 1 of 2018 - Extraordinary Gazette No. 2053/20, January 10, 2018
2. Amendments to the Rules for Financial Institutions (Customer Due Diligence) Rules, No. 1 of 2016 - Extraordinary Gazette No. 2092/02, October 08, 2018
3. Procedure of Conducting Risk Based Onsite Examinations, Circular No. 01 of 2018
4. Guidelines on ML & TF Risk Management for Financial Institutions, No. 1 of 2018
5. Guidelines on AML & CFT Compliance Obligations for Casinos and Gambling Houses, No. 02 of 2018
6. Guidelines on AML & CFT Compliance Obligations for Dealers in Real Estate and Precious Metals, Precious and Semi-Precious Stones, No. 03 of 2018
7. Guidelines for Financial Institutions on Identification of Beneficial Ownership, No. 04 of 2018
8. Guidelines, No. 5 of 2018 on Implementing United Nations (Sanctions in relation to Democratic People's Republic of Korea Regulations of 2017
9. Guidelines for Financial Institutions on Suspicious Transactions Reporting, No. 06 of 2018
10. Guidelines, No. 7 of 2018 on Implementing United Nations (Sanctions in relation to Iran) Regulations No. 1 of 2018

## 2017

1. Circular on onsite examination in terms of Risk-Based approach examination plan 2017 to CEOs of all Licensed Banks and Licensed Finance Companies
2. Guidelines on AML/CFT Compliance Obligations for Money or Value Transfer Service Providers, No. 1 of 2017
3. Suspicious Transactions (Format) Regulations of 2017 - Extraordinary Gazette No. 2015/56, March 30, 2017
4. Regulations Promulgating the Implementation of UNSCR 1718 on Democratic People's Republic of Korea - Extraordinary Gazette No. 2039/32 dated October 06, 2017
5. Regulations Promulgating the Implementation of UNSCR 1540 on Proliferation of Weapons of Mass Destruction (WMD) - Extraordinary Gazette No. 2039/31 dated October 06, 2017

## 2016

1. KYC/ CDD Rules for Financial Institutions - Extraordinary Gazette No. 1951/13, January 27, 2016
2. Circular on Definitions/ Clarifications for Financial Institutions (Customer Due Diligence) Rules No. 1 of 2016

## 2015

1. Reporting of Foreign Inward Remittances

## 2014

1. Prevention and Suppression of Terrorism and Terrorist Financing Obligations of Reporting Institutions - Authorized Money Changers
2. Prevention and Suppression of Terrorism and Terrorist Financing Obligations of Reporting Institutions (UNSCR 1373) - Licensed Banks and Licensed Finance Companies
3. Prevention and Suppression of Terrorism and Terrorist Financing (UNSCR 1373) - Obligations of Insurance Companies
4. Prevention and Suppression of Terrorism and Terrorist Financing (UNSCR 1373) - Obligations of Stockbrokers

## 2013

1. Circular to Directors of All Authorized Money Changing Companies, January 31, 2013
2. Public Statement by the Financial Action Task Force
3. Prevention and Suppression of Terrorism and Terrorist Financing Obligation of Reporting Institutions - All Licensed Banks & Licensed Finance Companies
4. Prevention and Suppression of Terrorism and Terrorist Financing Obligation of Reporting Institutions - Insurance Companies
5. Prevention and Suppression of Terrorism and Terrorist Financing Obligation of Reporting Institutions - Stock Brokering Companies

## 2012

1. Revisions to 40+9 Recommendations of the FATF
2. Notification from the FIU of St. Vincent and the Grenadines
3. Amendments to the KYC/ CDD Rules, No.1 of 2011 for the Licensed Banks and Licensed Finance Companies - Extraordinary Gazette No 1756/27, May 04, 2012

## 2011

1. KYC/ CDD Rules for Licensed Banks and Licensed Finance Companies - Extraordinary Gazette No 1699/10, March 28, 2011
2. Auditor's Declaration on Establishment of Audit Functions
3. Compliance with the Reporting Requirement under Section 7 of the FTRA
4. Revisions to Extraordinary Gazette Notification No. 1699/10 - KYC/CDD Rules, No. 01 of 2011

## 2010

1. Web based Information Reporting System to the Insurance Companies
2. Web based Information Reporting System to the Stockbrokers

## 2009

1. Compliance with the Section 2 of the FTRA - (for LBs)
2. Compliance with the Section 2 of the FTRA - (for RFCs)

3. Inclusion of the Tamil Foundation among the list of Terrorist Organizations in US
4. AML/CFT Compliance Functions of the Insurance Industry
5. Web Based Reporting System for LCBs & LSBs
6. Web Based Reporting System RFCs

## 2008

1. KYC/ CDD Rules for the Insurance Industry
2. Compliance with Rules on CDD for Financial Institutions
3. Compliance with Reporting Requirement (Amended)
4. Inclusion of the World Tamil Movement among the list of Terrorist Organizations in Canada
5. Use of Banking System by Institutions and Persons not Authorized to Accept Deposits
6. Compliance with Reporting Requirement of FTRA-Securities Industry
7. Compliance with Reporting Requirement of FTRA-Insurance Industry

## 2007

1. KYC/ CDD Rules for the Securities Industry
2. Compliance with KYC/CDD Rules for New Customers and existing Customers
3. Compliance with the Reporting Requirements under the FTRA
4. Light a Million Candles Campaign - Offences against Children
5. Mandatory Reporting Requirements - EFTs

## 2006

1. Compliance with the Reporting Requirement under the FTRA No 6 of 2006
2. Section 312 & Section 319 of the Patriot Act
3. FTRA No. 06 of 2006 Submission of Data
4. Financial Transactions Reporting Act, No. 06 of 2006
5. CDD for Inward Remittance

## Appendix B: Reporting Institutions (RIs) as at 31 December 2021

### Licensed Commercial Banks

1. Amana Bank PLC
2. Bank of Ceylon
3. Bank of China Ltd
4. Cargills Bank Ltd
5. Citibank, N.A.
6. Commercial Bank of Ceylon PLC
7. Deutsche Bank AG
8. DFCC Bank PLC
9. Habib Bank Ltd
10. Hatton National Bank PLC
11. Indian Bank
12. Indian Overseas Bank
13. MCB Bank Ltd
14. National Development Bank PLC
15. Nations Trust Bank PLC
16. Pan Asia Banking Corporation PLC
17. People's Bank
18. Public Bank Berhad
19. Sampath Bank PLC
20. Seylan Bank PLC
21. Standard Chartered Bank
22. State Bank of India
23. The Hongkong & Shanghai Banking Corporation Ltd
24. Union Bank of Colombo PLC

### Licensed Specialized Banks

1. HDFC Bank of Sri Lanka
2. National Savings Bank
3. Regional Development Bank
4. Sanasa Development Bank PLC
5. Sri Lanka Savings Bank
6. State Mortgage and Investment Bank

### Licensed Finance Companies

1. Abans Finance PLC
2. Alliance Finance Co. PLC

3. A M W Capital Leasing and Finance PLC
4. Arpico Finance Co. PLC
5. Asia Asset Finance PLC
6. Associated Motor Finance Co. PLC
7. Bimputh Finance PLC
8. CBC Finance Ltd
9. Central Finance Co. PLC
10. Citizens Development Business Finance PLC
11. Commercial Credit and Finance PLC
12. Commercial Leasing and Finance PLC
13. Dialog Finance PLC
14. ETI Finance Ltd
15. Fintrex Finance Ltd
16. HNB Finance Ltd
17. Ideal Finance Ltd
18. Kanrich Finance Ltd
19. Lanka Credit & Business Finance Ltd
20. LB Finance PLC
21. LOLC Development Finance PLC
22. LOLC Finance PLC
23. Mercantile Investments and Finance PLC
24. Merchant Bank of Sri Lanka & Finance PLC
25. Multi Finance PLC
26. Nation Lanka Finance PLC
27. Orient Finance PLC
28. People's Leasing & Finance PLC
29. People's Merchant Finance PLC
30. Prime Finance PLC
31. Richard Pieris Finance Ltd
32. Sarvodaya Development Finance Ltd
33. Senkadagala Finance PLC
34. Singer Finance (Lanka) PLC
35. Sinhaputhra Finance PLC
36. Siyapatha Finance PLC
37. Softlogic Finance PLC
38. Swarnamahal Financial Services PLC
39. Trade Finance & Investments PLC
40. UB Finance Company Ltd
41. Vallibel Finance PLC



## Licensed Insurance Companies

1. AIA Insurance Lanka Ltd
2. Allianz Insurance Lanka Ltd
3. Allianz Life Insurance Lanka Ltd
4. Amana Takaful Life PLC
5. Amana Takaful PLC
6. Arpico Insurance PLC
7. Ceylinco General Insurance Ltd
8. Ceylinco Life Insurance Ltd
9. Continental Insurance Lanka Ltd
10. Co-operative Insurance Co. Ltd
11. Cooplife Insurance Ltd
12. Fairfirst Insurance Ltd
13. HNB Assurance PLC
14. HNB General Insurance Ltd
15. Janashakthi Insurance PLC
16. Life Insurance Corporation (Lanka) Ltd
17. LOLC General Insurance Ltd
18. LOLC Life Assurance Ltd
19. MBSL Insurance Company Ltd
20. National Insurance Trust Fund
21. Orient Insurance Ltd
22. People's Insurance Ltd
23. Sanasa General Insurance Co. Ltd
24. Sanasa Life Insurance Co. Ltd
25. Softlogic Life Insurance PLC
26. Sri Lanka Insurance Corporation Ltd
27. Union Assurance PLC

## Licensed Stockbrokers

1. Acuity Stockbrokers (Pvt) Ltd
2. Asha Securities Ltd
3. Asia Securities (Pvt) Ltd
4. Assetline Securities (Pvt) Ltd
5. Bartleet Religare Securities (Pvt) Ltd
6. Candor Equities Ltd
7. Capital Alliance Ltd - (Debt Securities)
8. Capital Alliance Securities (Pvt) Ltd
9. Capital Trust Securities (Pvt) Ltd

10. CT CLSA Securities (Pvt) Ltd
11. Enterprise Ceylon Capital (Pvt) Ltd
12. First Capital Equities (Pvt) Ltd
13. First Guardian Equities (Pvt) Ltd
14. J B Securities (Pvt) Ltd
15. John Keells Stockbrokers (Pvt) Ltd
16. Lanka Securities (Pvt) Ltd
17. LOLC Securities Ltd
18. Nation Lanka Equities (Pvt) Ltd
19. Navara Securities (Pvt) Ltd
20. NDB Securities (Pvt) Ltd
21. NSB Fund Management Co. Ltd - (Debt Securities)
22. Richard Pieris Securities (Pvt) Ltd
23. S C Securities (Pvt) Ltd
24. SMB Securities (Pvt) Ltd
25. Softlogic Stockbrokers (Pvt) Ltd
26. Somerville Stock Brokers (Pvt) Ltd
27. Taprobane Securities (Pvt) Ltd
28. TKS Securities (Pvt) Ltd
29. Wealth Trust Securities Ltd - (Debt Securities)

## Restricted Dealers

1. A.H.M. Trading (Pvt) Ltd
2. A.O.Lakshmi Jewels (Pvt) Ltd
3. Abdeen Money Changers (Pvt) Ltd
4. Abilash Money Exchange (Pvt) Ltd
5. Ariyawansa Enterprises (Pvt) Ltd
6. Arrujina Jewellery (Pvt) Ltd
7. Aruna Forexc (Pvt) Ltd
8. Asia Asset Finance PLC
9. Asian Money Exchange (Pvt) Ltd
10. Bimpuh Finance PLC
11. Brescia Grameen (Pvt) Ltd
12. Bullion Money Exchange (Pvt) Ltd
13. Capital Exchange (Pvt) Ltd
14. Carlo International (Pvt) Ltd
15. Central Money Exchange (Pvt) Ltd
16. Citizens Development Business Finance PLC
17. City Exchange (Pvt) Ltd
18. Colombo Money Exchange (Pvt) Ltd - Head Office - Colombo 06

- Branch - Colombo 01

19. Crown Money Exchange (Pvt) Ltd
20. Dadigama Group (Pvt) Ltd
21. Data Exchange International (Pvt) Ltd
22. Daya Authorized Money Changer (Pvt) Ltd
23. Delta Sarath Holdings (Pvt) Ltd
24. Devi Forex (Pvt) Ltd
25. Galle Money Exchange (Pvt) Ltd - Head Office - Galle  
- Branch - Galle Fort
26. George Michael Holdings (Pvt) Ltd
27. Gexon Exchange (Pvt) Ltd
28. Global Trust Money Exchange (Pvt) Ltd
29. Global Village Exchange (Pvt) Ltd
30. Golden Money Changers (Pvt) Ltd
31. Haifa Travels and Tours (Pvt) Ltd
32. International Exchange (Pvt) Ltd
33. Jayes Investments Ltd
34. Jewel Lanka Money Exchange (Pvt) Ltd
35. Jeya Forex Exchange (Pvt) Ltd
36. Kamal Enterprises (Pvt) Ltd
37. Keyser Exchange (Pvt) Ltd
38. Kudamadu Money Exchange (Pvt) Ltd
39. L B Finance PLC
40. Lanka Credit and Business Finance Limited
41. M.P. Money Changer (Pvt) Ltd
42. Maruthi Money Exchange (Pvt) Ltd - Head Office - Colombo 06  
- Branch - Jaffna
43. Mayurie Money Changers (Pvt) Ltd
44. Mercantile Merchant Bank Ltd
45. Metro Forex (Pvt) Ltd
46. Midna Mini Market (Pvt) Ltd
47. Milano Money Exchange (Pvt) Ltd
48. Narmatha Gold Centre (Pvt) Ltd - Head Office - Jaffna  
- Branch - Kilinochchi
49. New Natasha (Pvt) Ltd
50. New Regal's Money Changer (Pvt) Ltd
51. Pearl City Hotel
52. Pearl Exci (Pvt) Ltd
53. Prasanna Money Exchange (Pvt) Ltd - Head Office - Colombo 01  
- Branch - Colombo 06
54. Pushpa Money Changer (Pvt) Ltd

55. Rafeek's Gems (Pvt) Ltd
56. Ravi Forexae (Pvt) Ltd
57. Rimha Jewellery (Pvt) Ltd
58. Rivindu Enterprises (Pvt) Ltd
59. Royal Money Exchange (Pvt) Ltd - Head Office - Colombo 01  
- Branch - Colombo 06
60. Royal Money Mart (Pvt) Ltd - Head Office - Aluthgama  
- Branch - Colombo 01
61. S S D D Money Exchanging (Pvt) Ltd
62. Salaka Trust Investment (Pvt) Ltd
63. Senkadagala Finance PLC
64. Shangri-La Hotel Colombo
65. Shangri-La's Hambantota Resort & Spa
66. Sharanga Money Exchange (Pvt) Ltd
67. Shifaz Money Exchange (Pvt) Ltd
68. Singer Finance (Lanka) PLC
69. Sinhaputhra Finance PLC
70. Sornam Forex (Pvt) Ltd
71. Swiss Money Exchange (Pvt) Ltd - Head Office - Colombo 01  
- Branch - Colombo 06
72. Thamasha Forex (Pvt) Ltd
73. Thomas Cook Lanka (Pvt) Ltd - Head Office - Bandaranaike International Airport  
- Branch - Colombo 02 (Colombo City Centre)  
- Branch - Colombo 02 (One Galle Face Mall)  
- Branch - Kandy
74. Unic Forex (Pvt) Ltd
75. Universal Money Changers (Pvt) Ltd
76. Vasanthas Intl. Money Exchange (Pvt) Ltd
77. Western Money Exchange (Pvt) Ltd
78. Windsor Money Exchange (Pvt) Ltd

\* LICENSED FINANCE COMPANIES ARE PERMITTED TO ENGAGE IN THE MONEY CHANGING BUSINESS ONLY AT THE BRANCHES AUTHORIZED BY DFE.

### Money or Value Transfer Services

1. Dialog Axiata PLC
2. MMBL Money Transfer (Pvt) Ltd
3. Mobitel (Pvt) Ltd

